

Indirect taxes

Class room work teaching charts

May 2013 exams

CA N.Rajasekhar M.com FCA DISA (ICAI)

Chennai.

94440149860

rajdhost@yahoo.com

Every attempt is made to avoid errors and omissions; if any error crept it is unintentional.

All rights are reserved. No part of these charts shall be reproduced, transmitted by any means without written permission of author.

Indirect taxes Classes at Chennai and Bangalore

Chennai: Premier Academy Mylapore

044-24622694 / 9841661405

Bangalore: Shraddha academy

Rajaji Nagar, Bangalore

9141 888 592

23420603

Excise Charging section. Sec. 3 of CEA

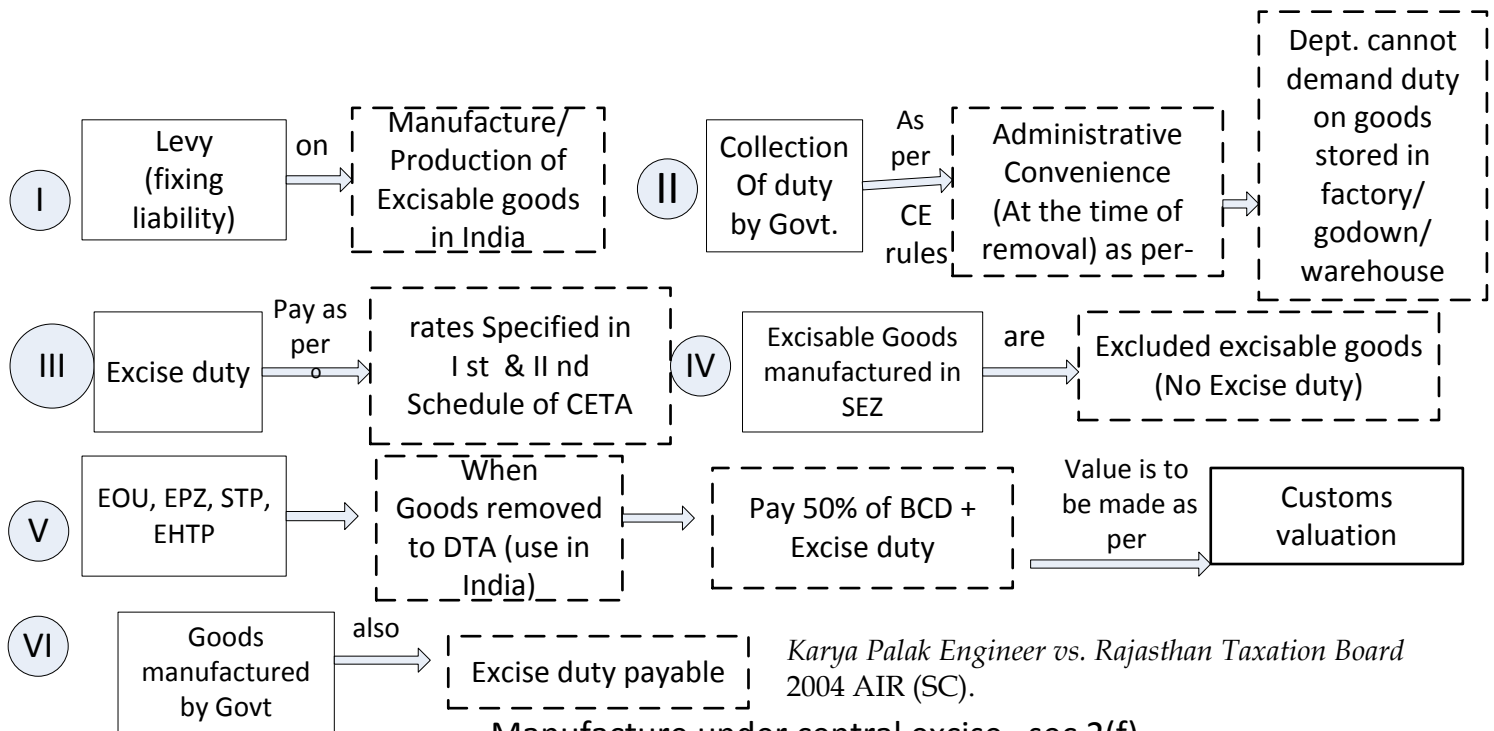

Manufacture under central excise sec 2(f)

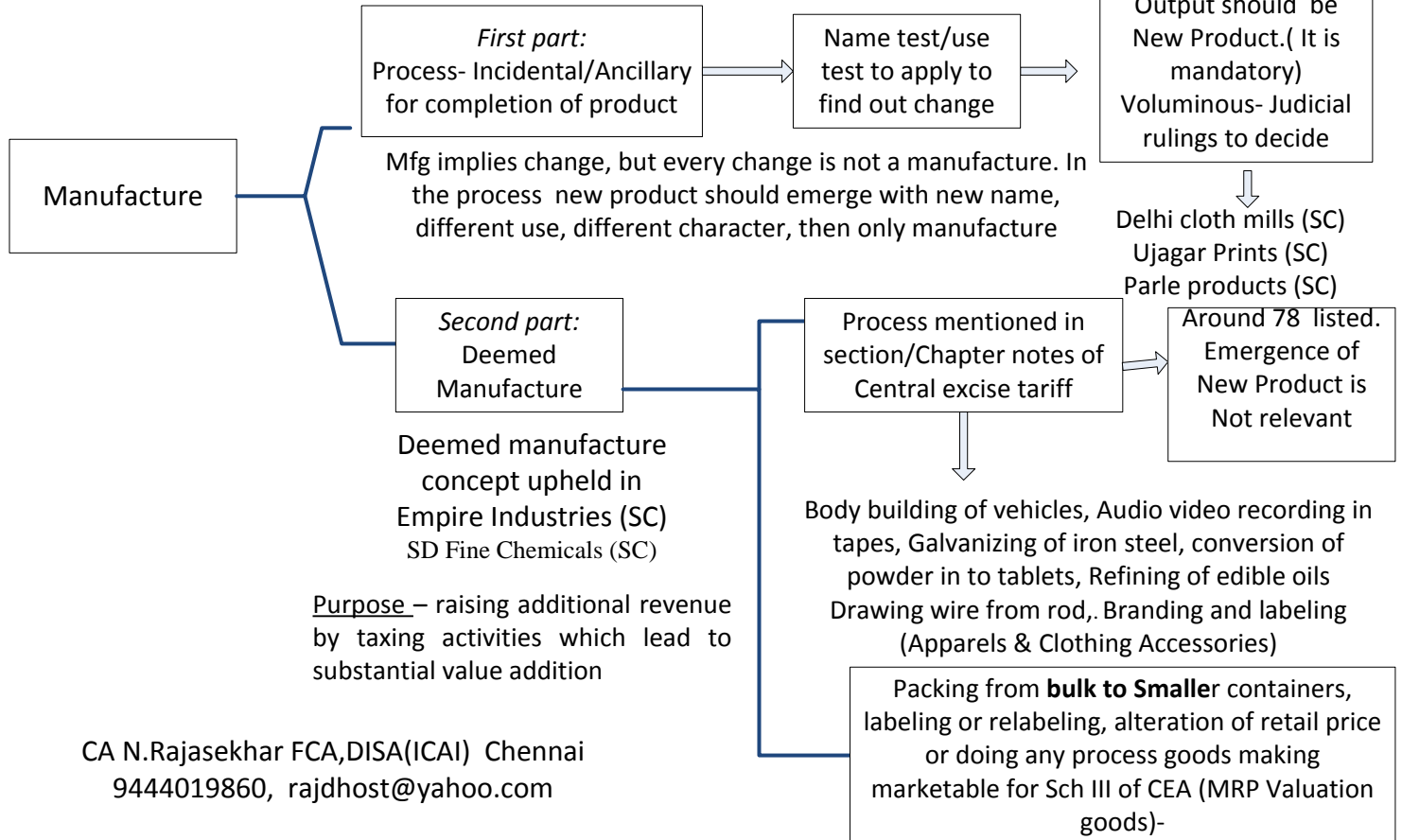

CA N.Rajasekhar FCA,DISA(ICAI) Chennai
9444019860, rajdhost@yahoo.com

- 1. Value addition in the packing activity is mandatory to call as deemed manufacture and levy of ED.
- 2. If goods are already marketable, mere packing and repacking them is not a manufacture.
- 3. Labeling/relabeling should include declaration or alteration of retail sale price. mere labeling or relabeling will not be 'deemed manufacture' *Mumbai vs. BOC (I) Ltd. 2008 (226) ELT 323 (SC)*

India for the purpose of Excise duty

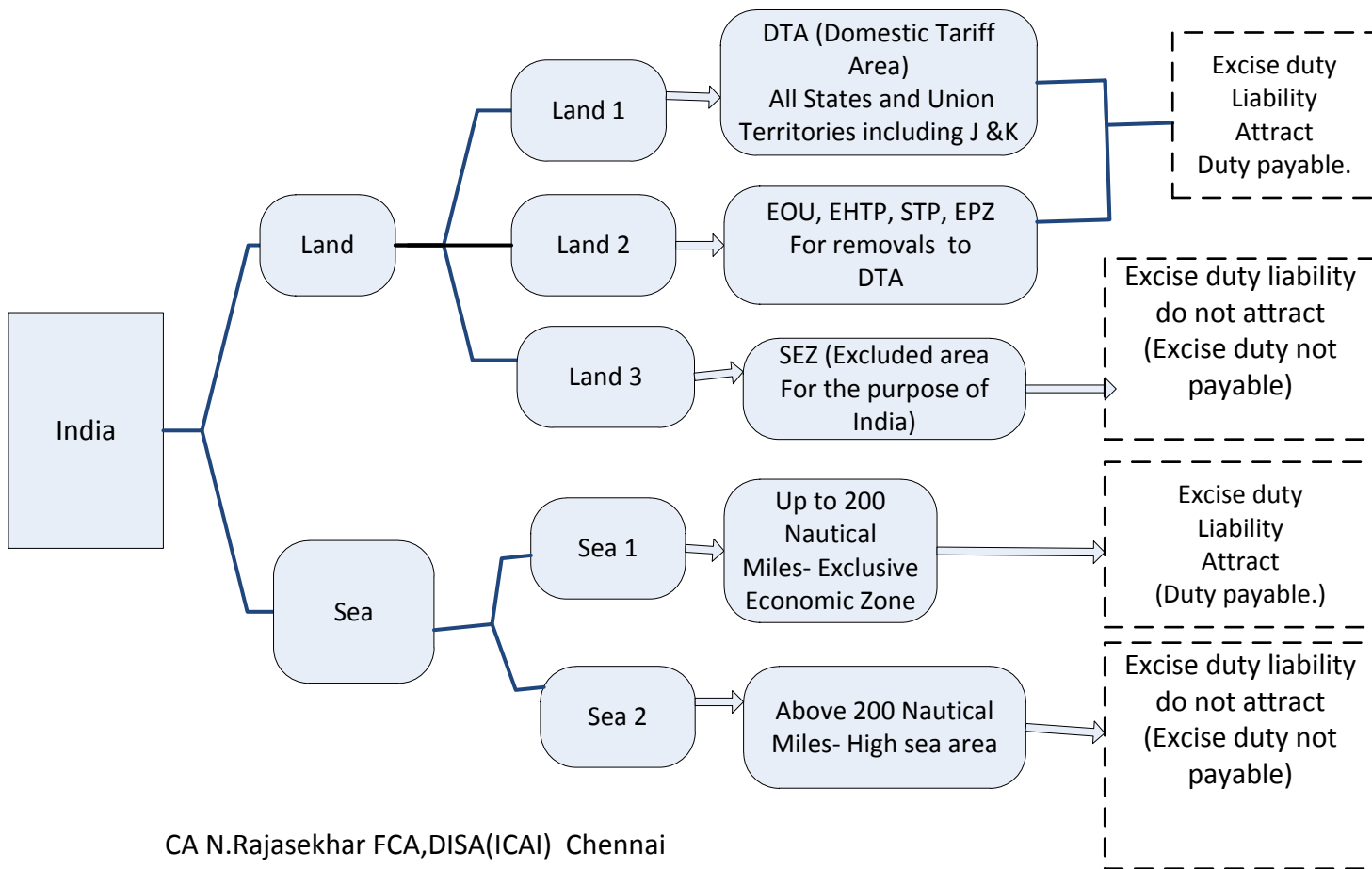

CA N.Rajasekhar FCA,DISA(ICAI) Chennai
9444019860, rajdhost@yahoo.com

For Detailed and simplified full coverage of charts and other topics
Read
Simplified Approach to IDT, By CCH Publishers,gurgoan
3rd edition for May 2013
Available in all leading book stalls
Online stores:
[cchindiastores](http://cchindiastores.com),lawbookshop.net,jainbookdepot.com,flipkart.com

Goods and Excisable goods

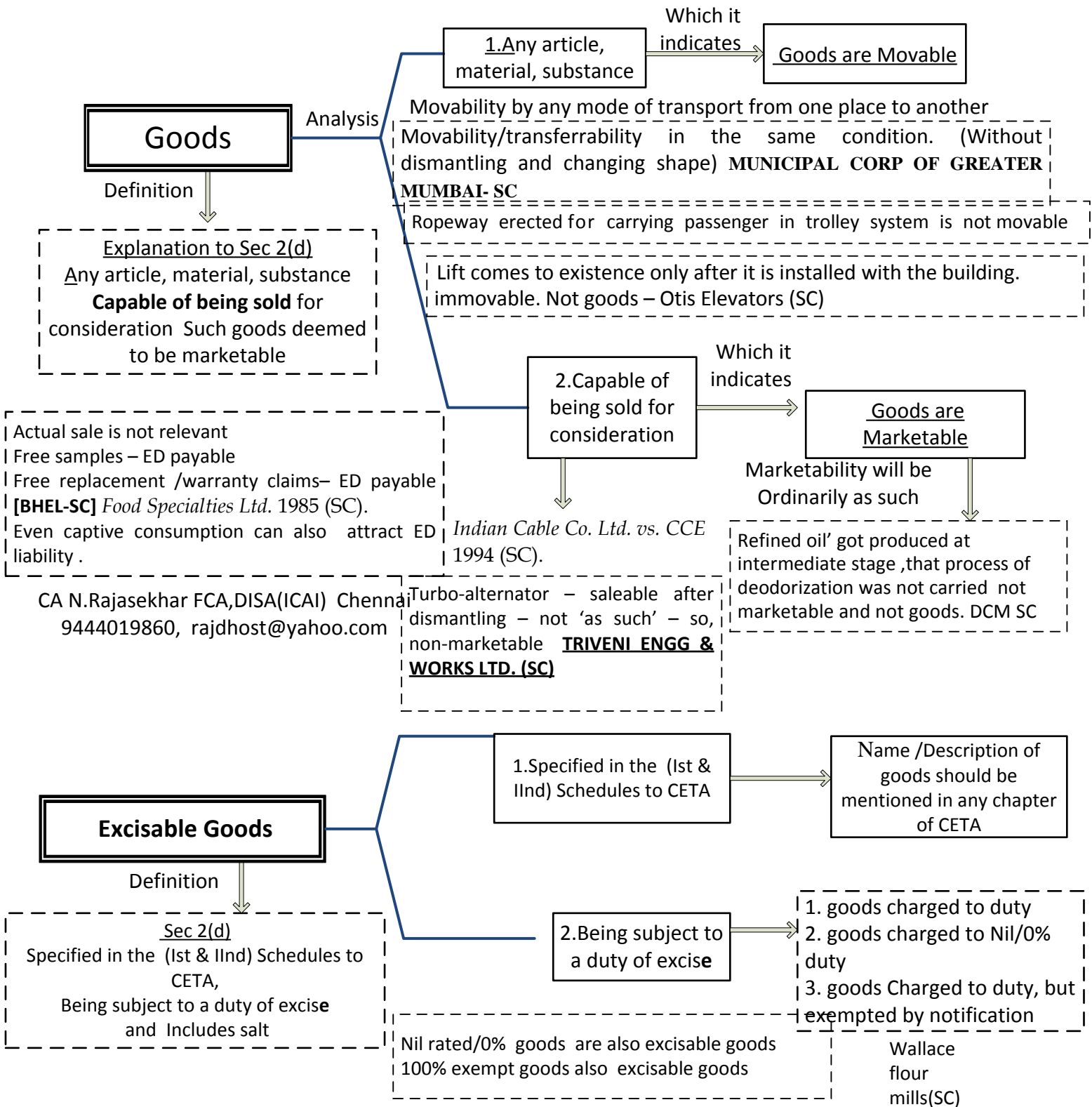

Specification in Schedule is not determinative or conclusive as to marketability

Item specified in Schedule – but not proved to be marketable --- not excisable – (as marketability is the decisive test)

Conclusion:

In order to attract excise duty liability, goods should be movable, marketable and excisable
Bhor industries ltd (Sc)
Ion exchange Ltd (SC)

Issues in Manufacture

Whether Assembling is a – Manufacture or not

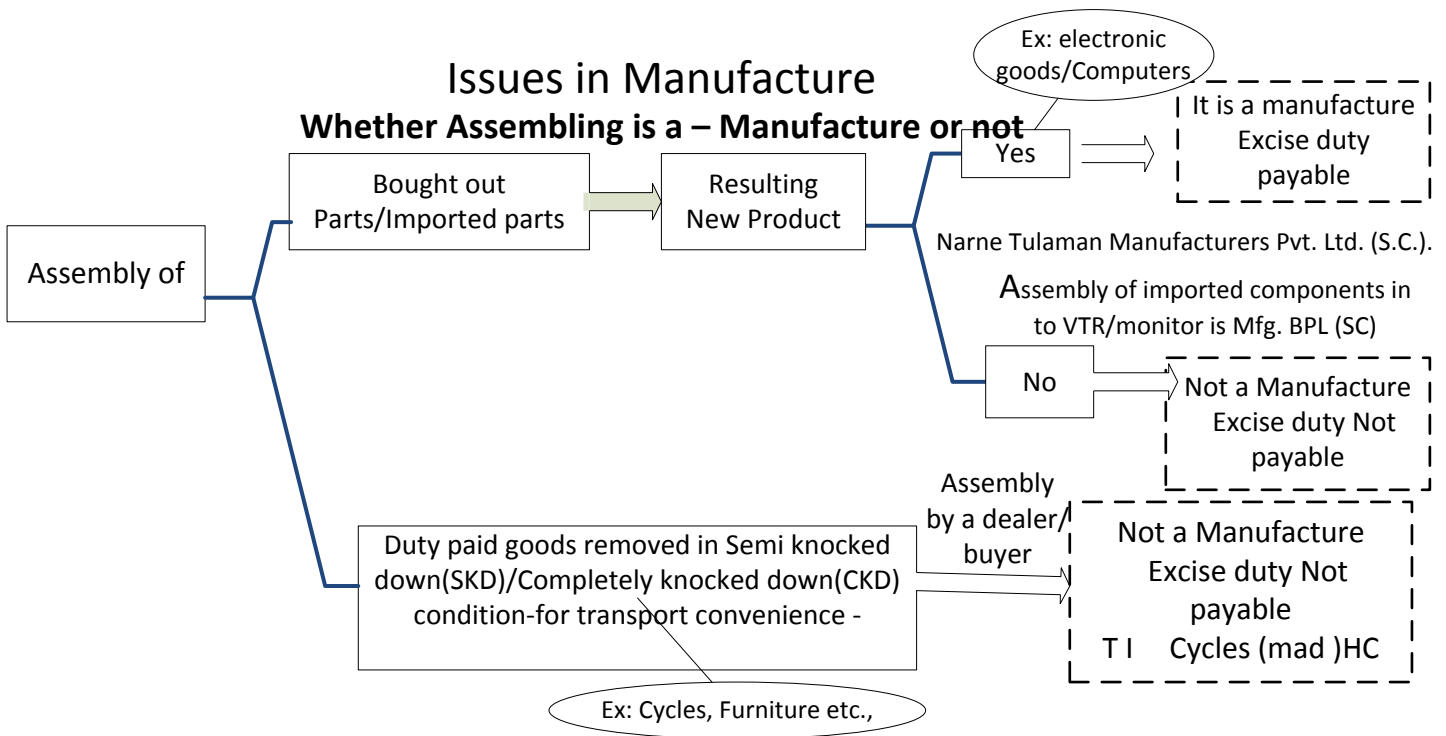

Assembly of components of air conditioner in car does not amount to manufacture - CBE&C Circular dt. 17-8-1999.

Whether Curing is a Manufacture or not

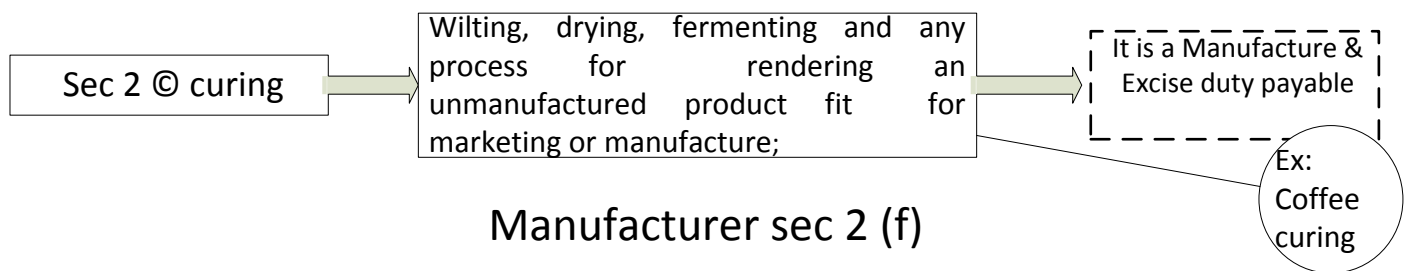

Manufacturer sec 2 (f)

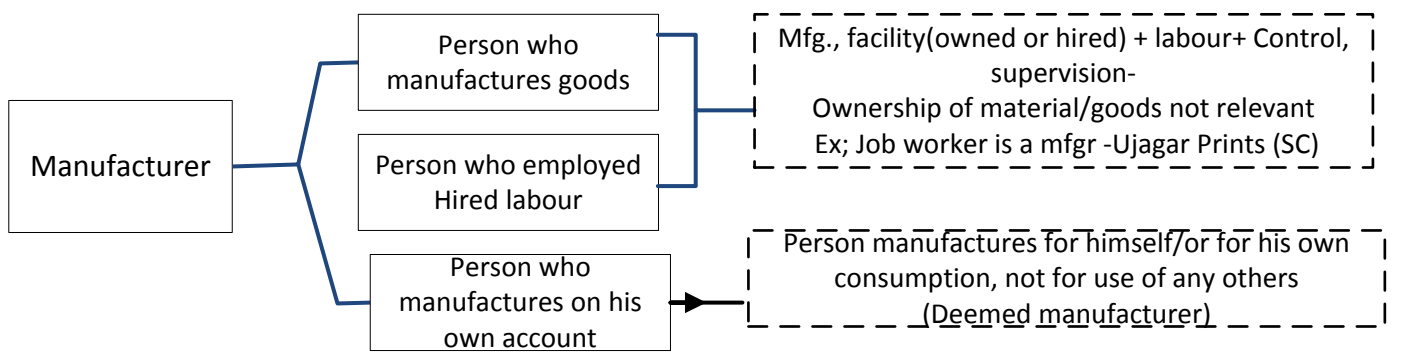

RM Supplier, brand name owner, loan licensee are not manufacturer
 Cibatul Ltd. vs. UOI 1978 (SC)/Philips India Ltd. vs. UOI (All HC) Food Specialties Ltd. 1985 (SC)

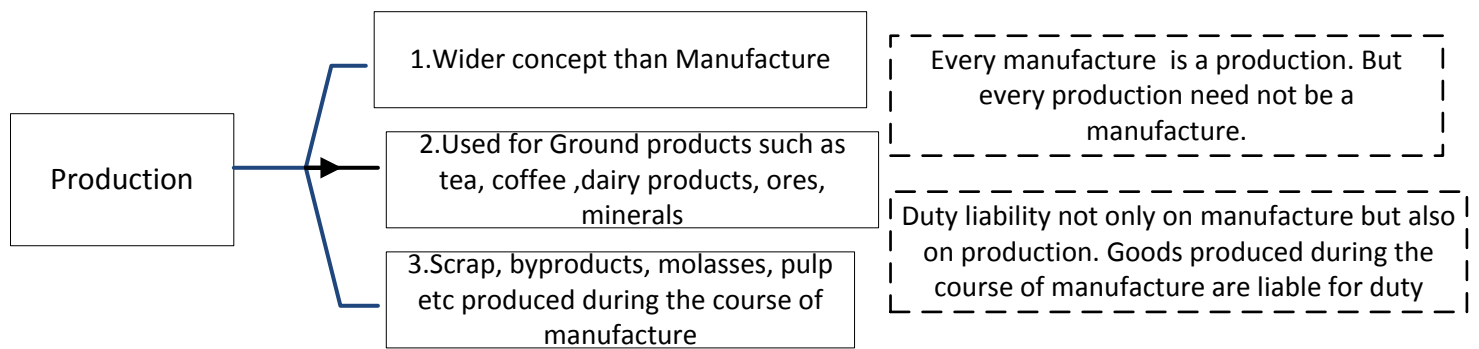

Dutiability of site related activities/ Structures, erections, assembly at site

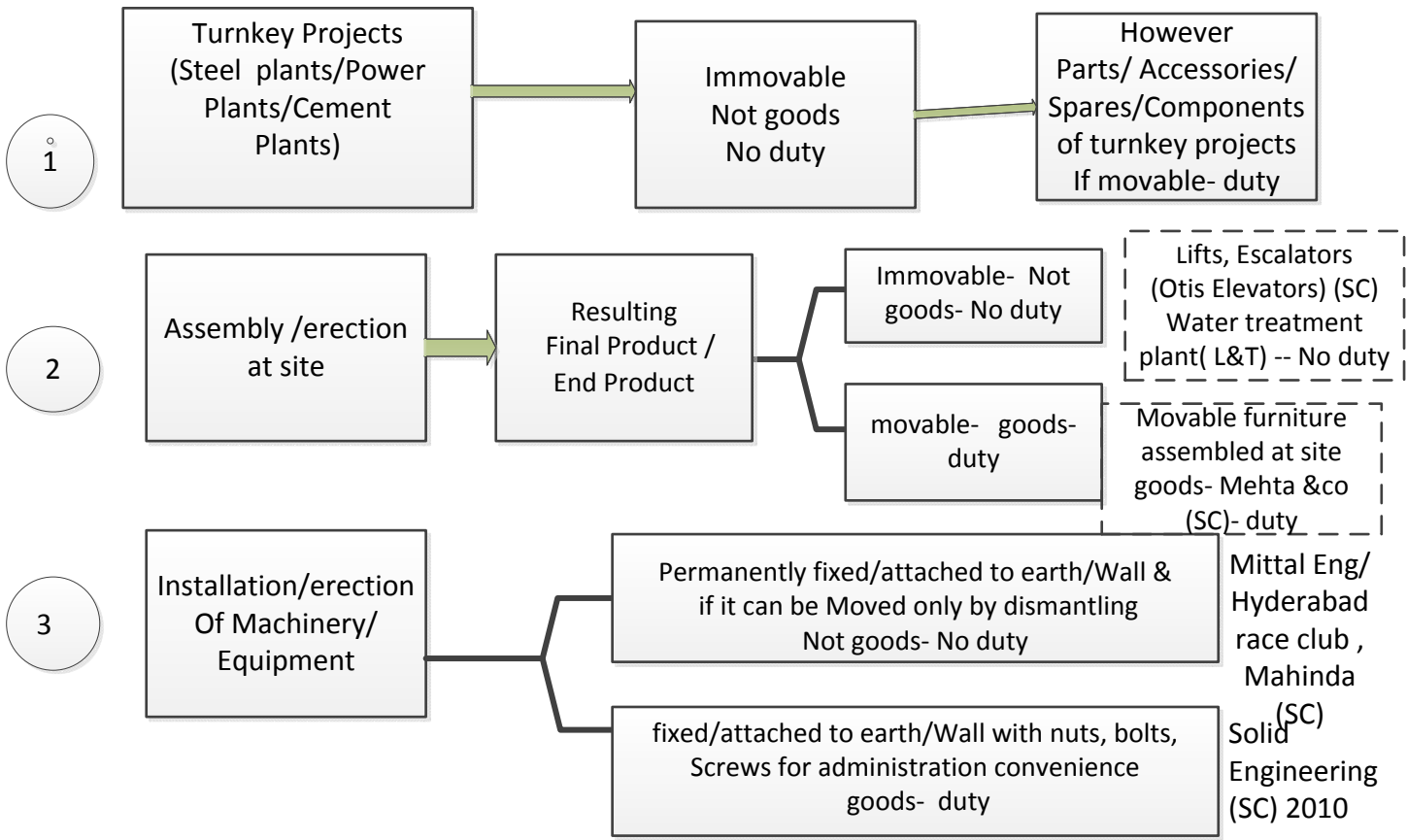

Khandelvalmetal Metal Engineering (SC)
Indian Aluminum Co (SC)

Dutiability of Waste/Scrap

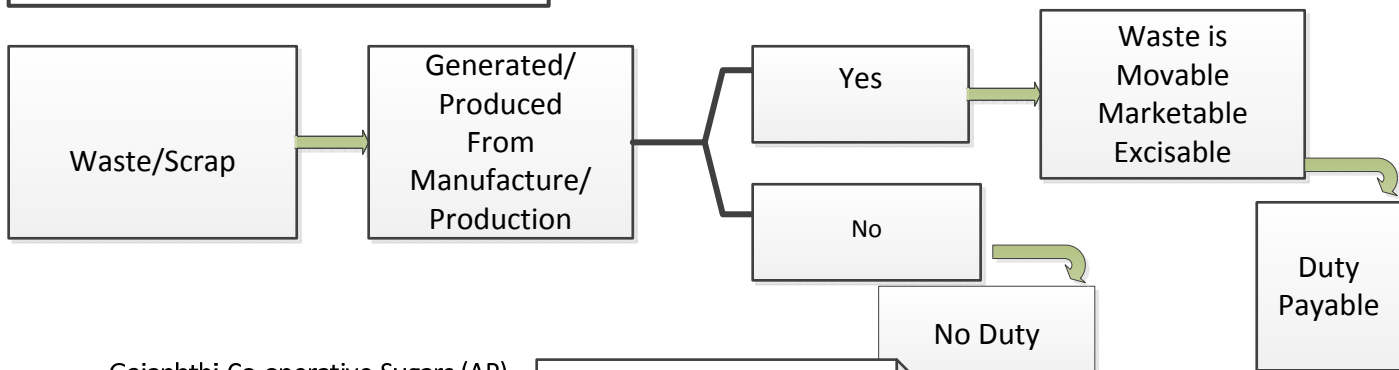

Gajaphthi Co-operative Sugars (AP)

Banswara Syntex Ltd (Raj)

Prism Cement Ltd. 2008 232
ELT 564 (Delhi Tribunal)

Waste generated through building demolition/pipe cutting/works contract/ machinery demolition/ repairing activity
No duty, even if it movable, marketable and excisable

For Detailed and simplified full coverage of charts and other topics
Read
Simplified Approach to IDT, By CCH Publishers, gurgoan
3rd edition for May 2013
Available in all leading book stalls
Online stores:
indiacchstores, lawbookshop.net, jainbookdepot.com, flipkart.com

CA N.Rajasekhar FCA, DISA (ICAI) Chennai
9444019860, rajdhost@yahoo.com

Duty liability on Captive Consumption

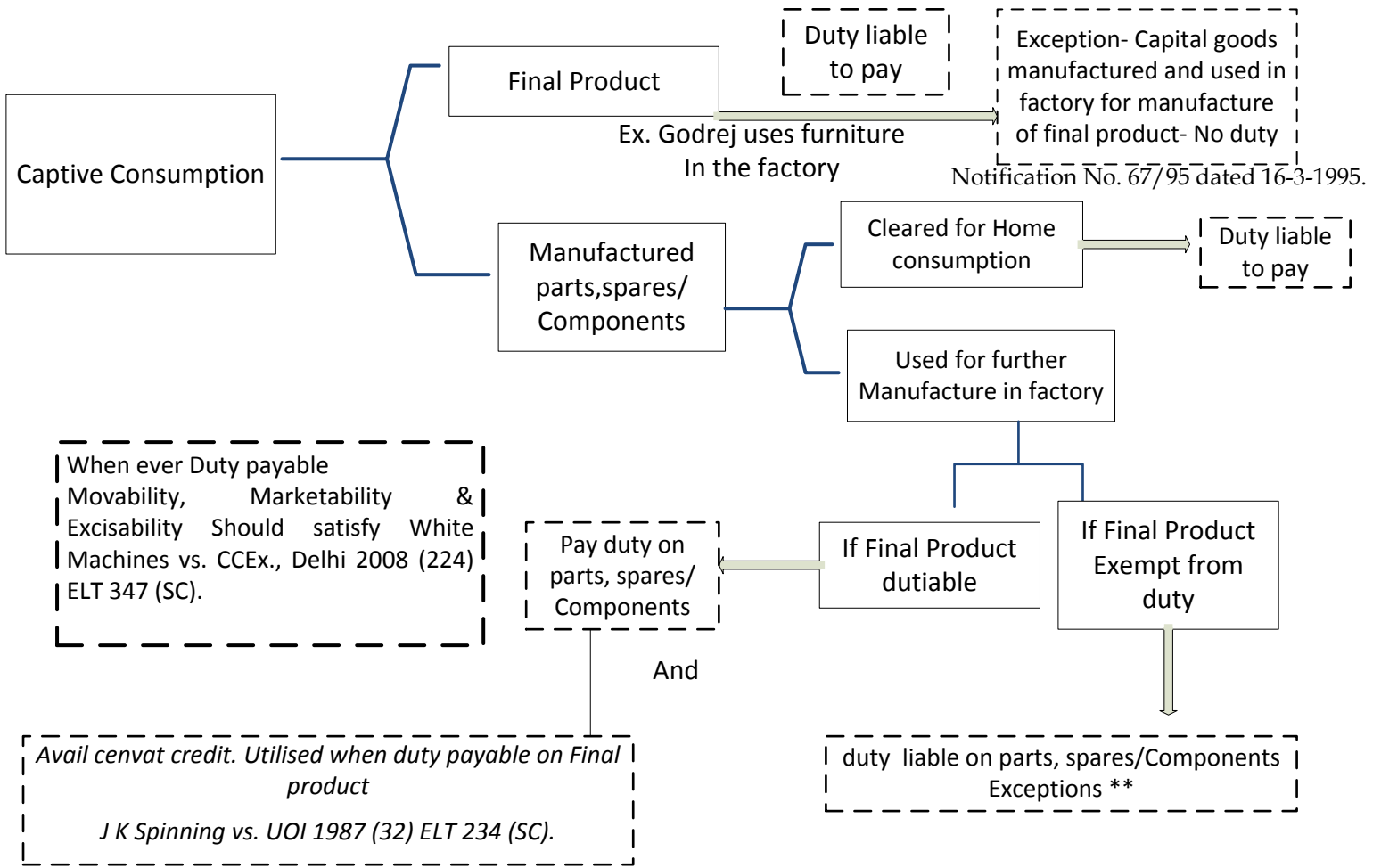

Duty liability on Intermediate products

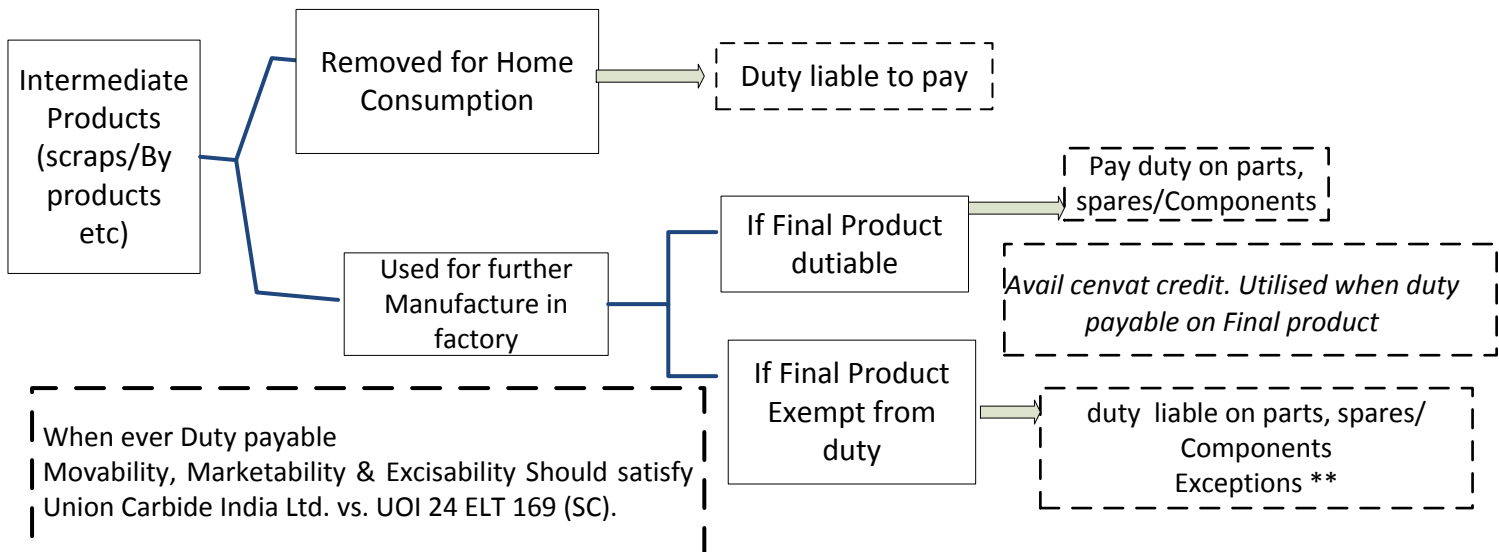

Exceptions ** No duty on Ip/Spares components etc., even F P is exempt

- Final product cleared for deemed export i.e., cleared to EOU, STP/EHTP
- Final products cleared to ILO, WHO, UNDP, UNIDO, defense ,railways, navy etc. are exempt under Notification
- Final product cleared by SSI under availing turnover exemption. However, if final product is fully exempt under any other notification, duty will be payable on intermediate product, or its value will be considered for calculating limits
- Final product is cleared for export under bond/payment of amount of 5% as per cenvat credit rule

Change in rate of duty & Applicable rate of duty for payment

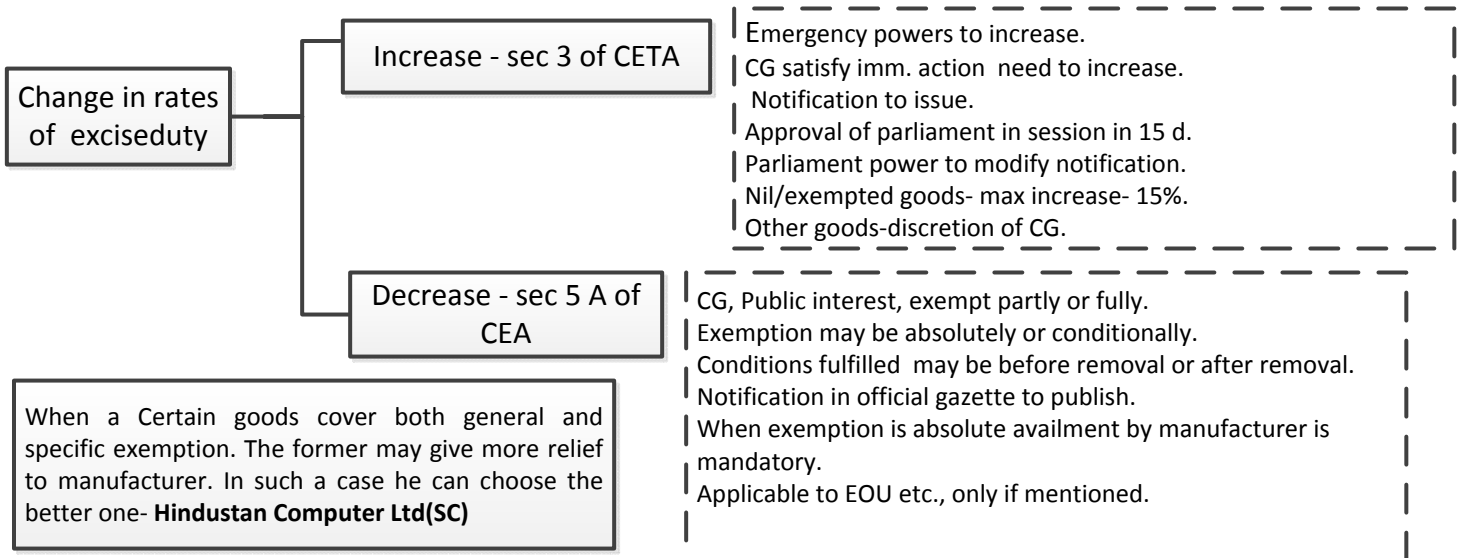

Rate of duty applicable for payment/ Taxable event- Rule 5

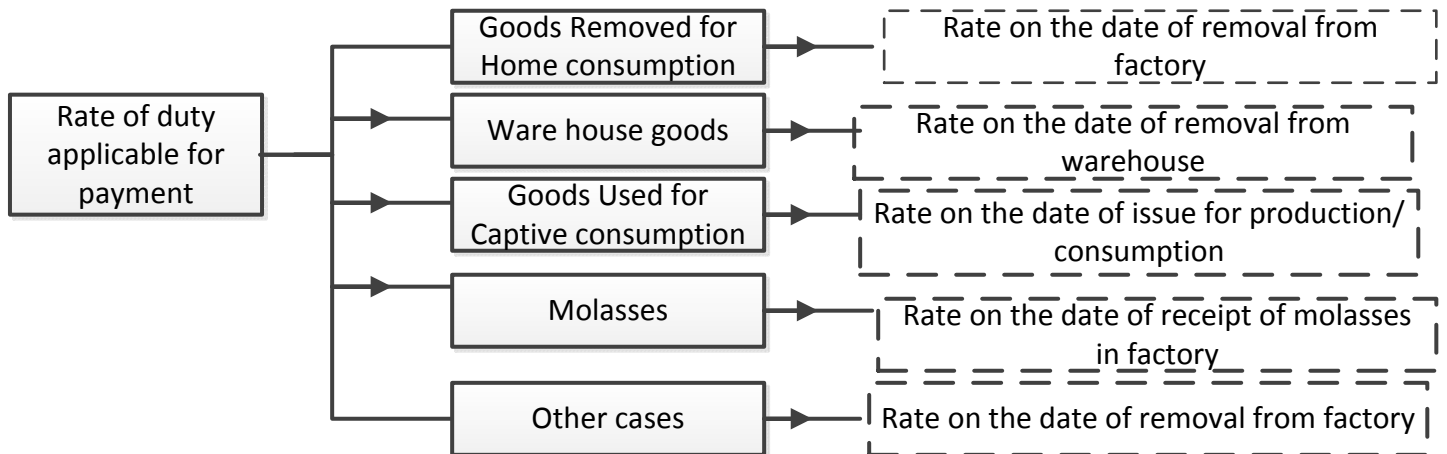

CA N.Rajasekhar FCA,DISA(ICAI) Chennai
9444019860, rajdhost@yahoo.com

Rate of duty in case pre budget stock- Taxable event

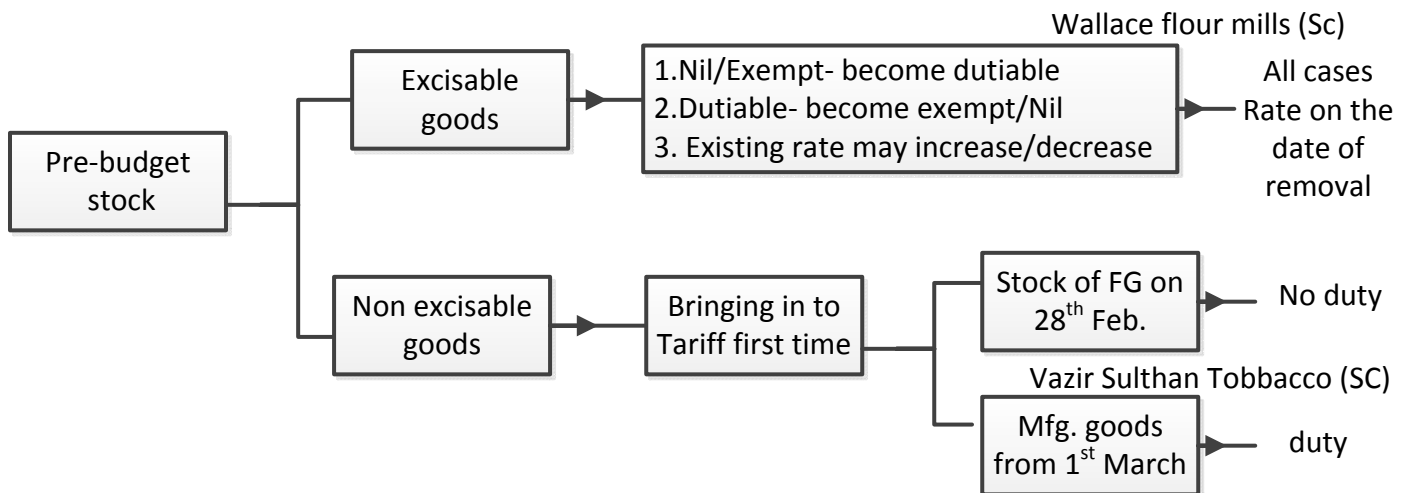

CA N.Rajasekhar FCA,DISA(ICAI) Chennai
9444019860, rajdhost@yahoo.com

Duty liability & duty Remission(waiver)

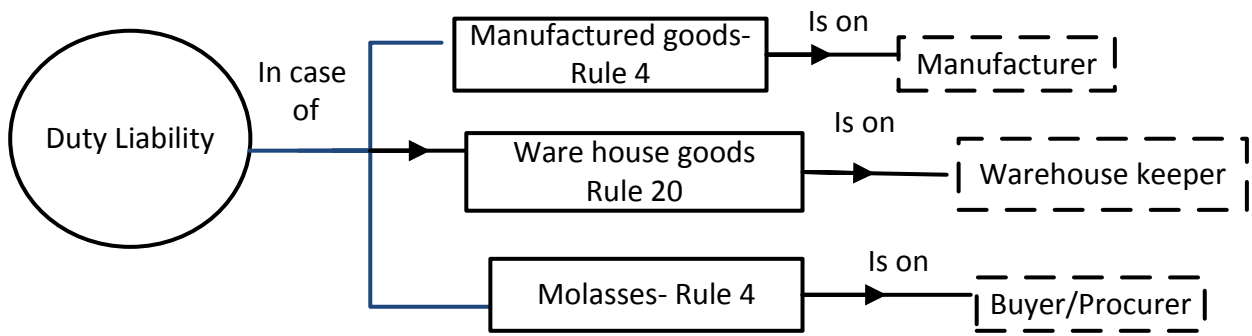

Ownership of goods is not relevant for payment of duty -Moriroku UT India P Ltd (SC)./Hindustan General Industries (CEGAT) and Mahindra & Mahindra (CEGAT).

Duty payable even if is not charged or collected- in such case it is cumduty price (price inclusive of duty)- Maruti Udyog (SC)

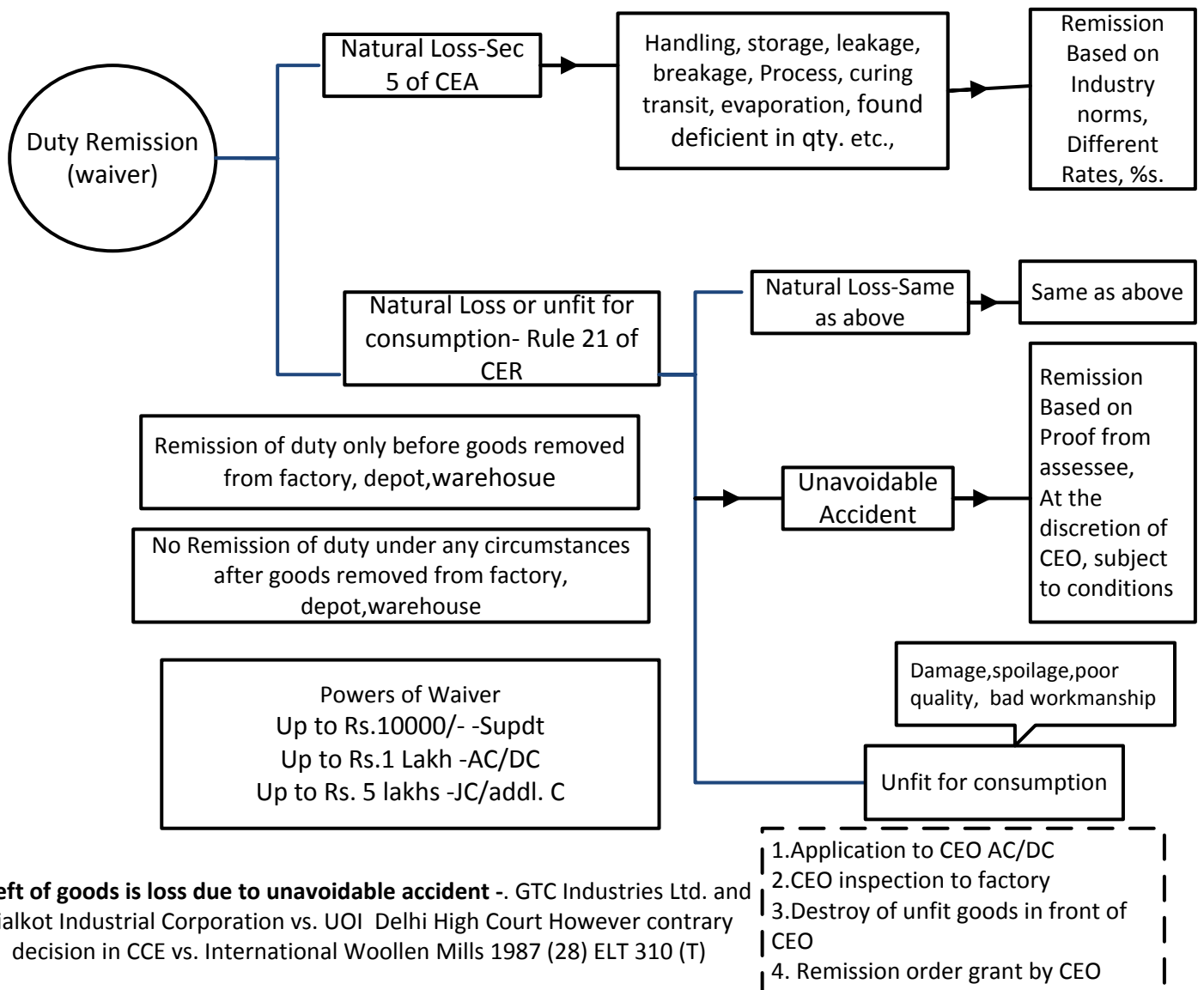

Theft of goods is loss due to unavoidable accident -. GTC Industries Ltd. and Sialkot Industrial Corporation vs. UOI Delhi High Court However contrary decision in CCE vs. International Woollen Mills 1987 (28) ELT 310 (T)

CA N.Rajasekhar FCA,DISA(ICAI) Chennai
9444019860, rajdhost@yahoo.com

Excise Classification 1

Classification implies, Grouping and subgrouping of goods under various chapter for rate of duty purpose.
 Coverage- CETA- Schedule I – Basic excise duty & Schedule II- special excise duty

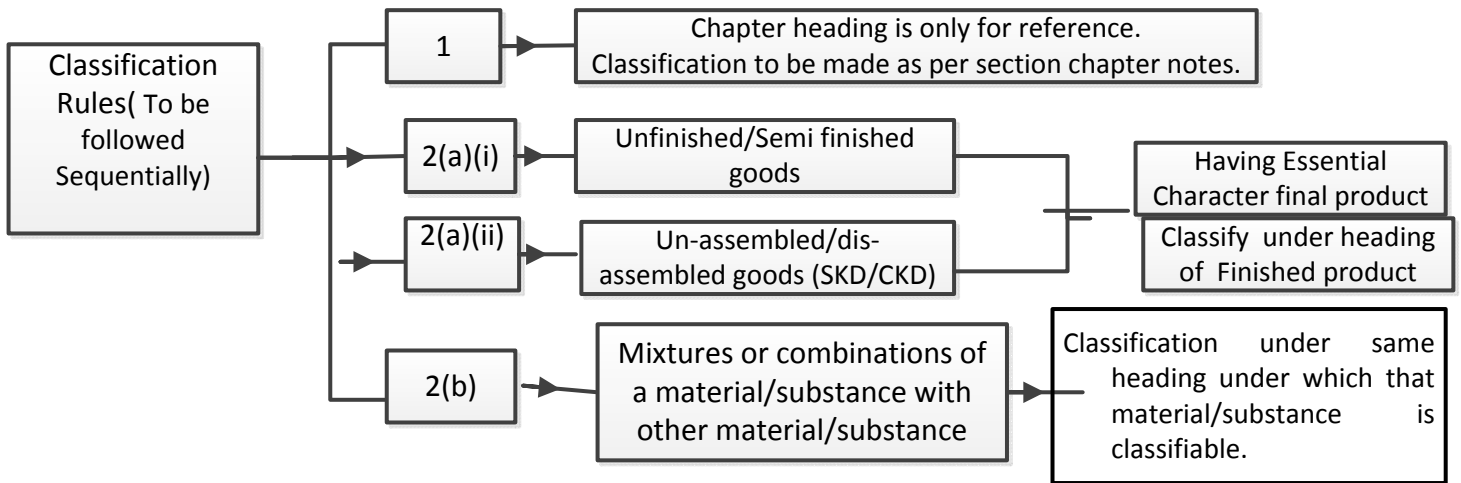

If goods are classifiable under two or more heading as per rule 2(b) or under any other reason classify goods under following order

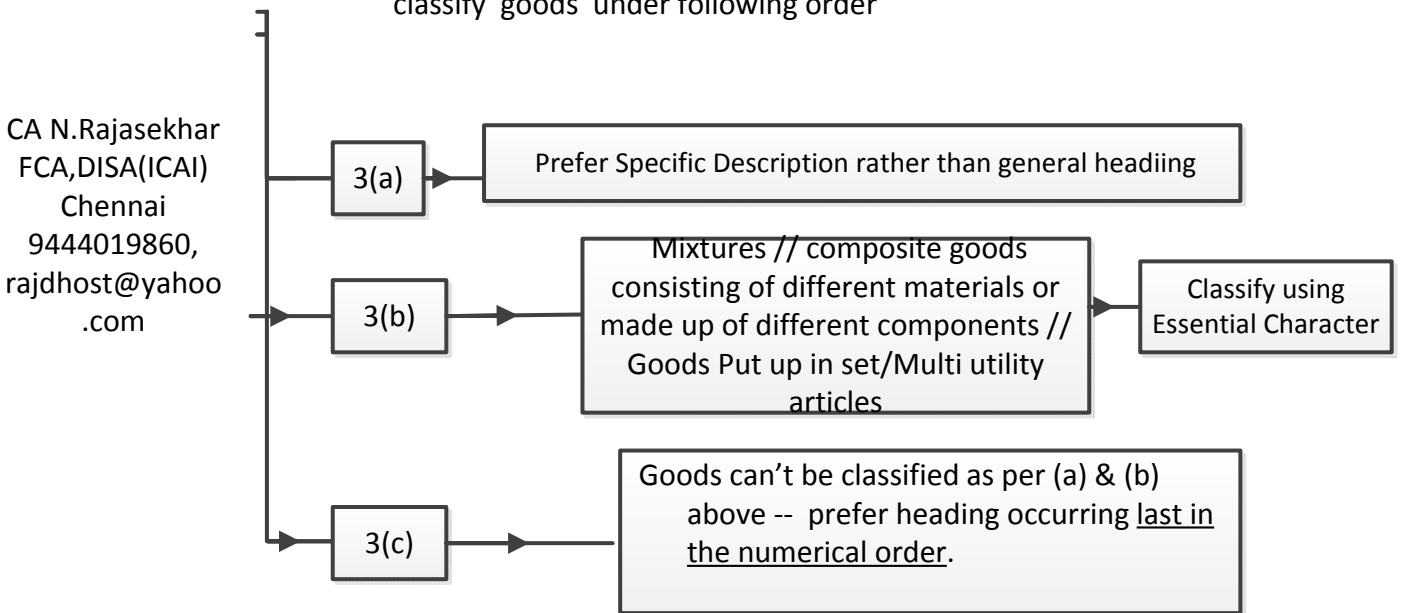

Goods not classifiable as per Rule 1 to 3(c) above, Classify under rule 4

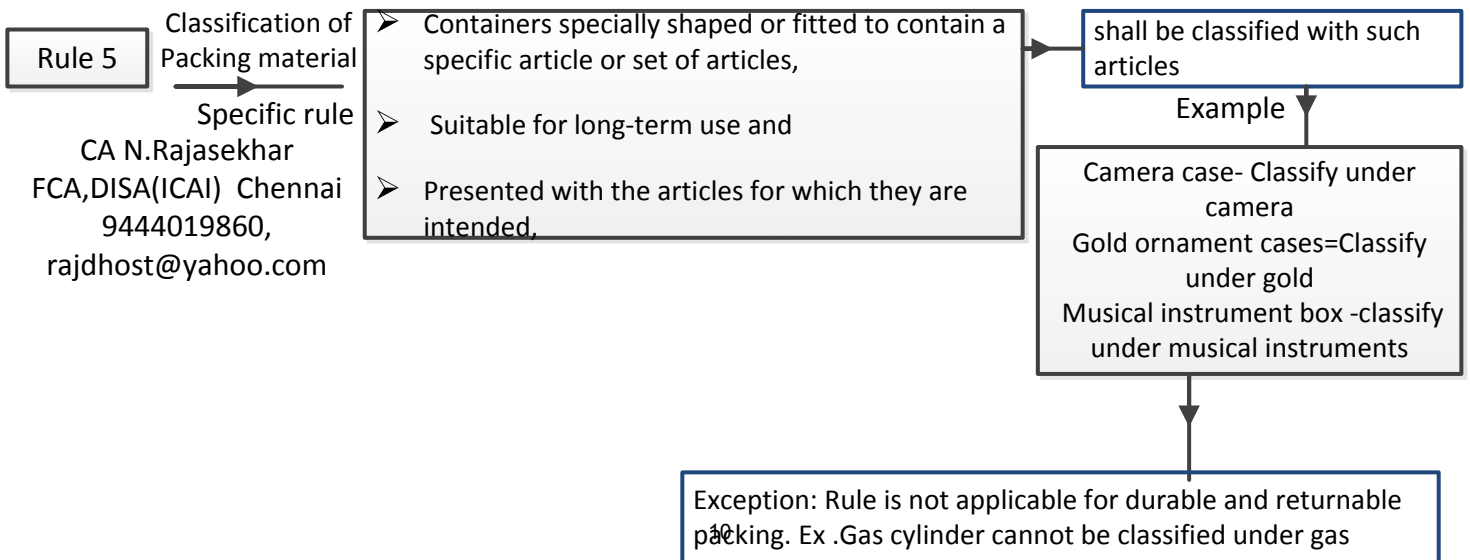
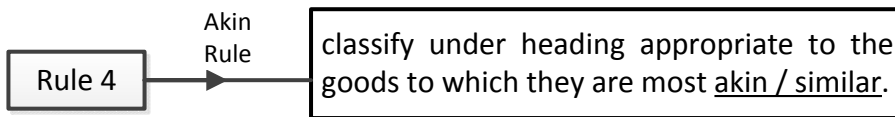

Excise Classification 2

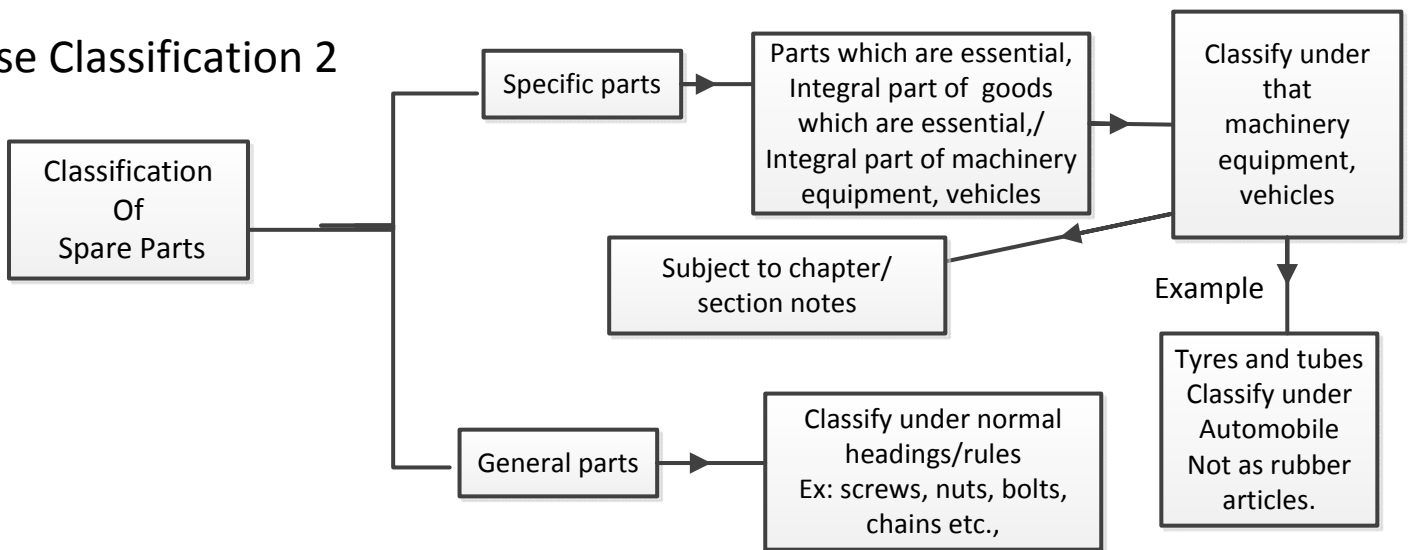

Non Statutory Classification rule

Trade parlance Theory/Common Man theory of classification

Applicable only when classification is not possible under rule 1 to 5

Words used in CETA but not defined separately, to be understood according to the common commercial understanding.

The consumer buys an article because it performs a specific function for him. This mental association with a product is highly important for classification - *Atul Glass Industries (P.) Ltd. vs. CCE (1986) (SC)*.

Classification has to be made based on customer use and identity of a product.

Example

- Lal Dant Manjan (Red Tooth Powder) cannot be classified as a Medicine. It is tooth powder only.
- Mineral Water cannot be classified as a beverage.
- Mirror cannot be classified as glass article. It is cosmetic item only.
- Plastic torch cannot be classified as plastic article.
- Windscreen cannot be classified as glass article. It is automobile part only.
- Prickly heat powder cannot be classified as toiletry preparations and should be classified as medicines

For Detailed and simplified full coverage of charts and other topics
Read

Simplified Approach to IDT, By CCH Publishers, Gurgaon
3rd edition for May 2013

Available in all leading book stalls

Online stores:

cchindiastores.com, lawbookshop.net, jainbookdepot.com, flipkart.com

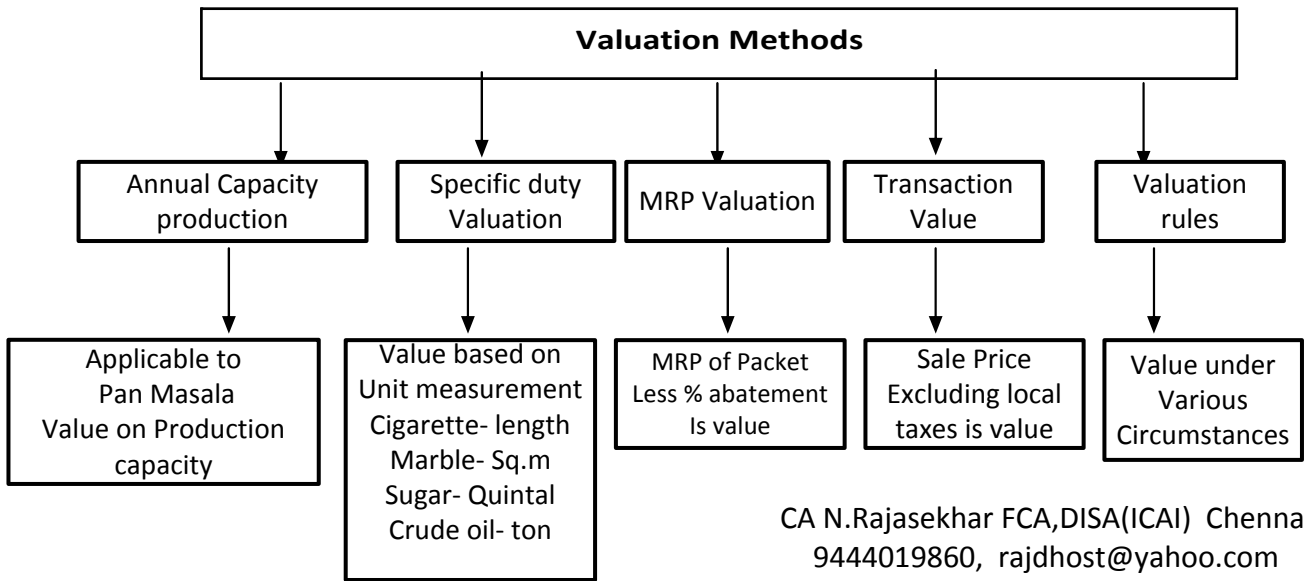

MRP Valuation

Meaning of MRP:

Maximum price at which the excisable goods in packaged form may be sold to the ultimate consumer

MRP includes all taxes local or otherwise, freight, transport charges, commission payable to dealers, and all charges towards advertisement, delivery, packing, forwarding

Example

A detergent bar 50 grams is manufactured in Pondicherry And supplied to Andhra Pradesh

Total Cost Rs. 6.00	+	Profit Rs. 1.00	+	Excise & CST Rs. 0.75	+	Dealer Commission Rs.0.50	+	Advt etc. Other Exp Rs.1.00	+	A. P Vat Rs. 0.75
------------------------	---	--------------------	---	--------------------------	---	---------------------------------	---	-----------------------------------	---	----------------------

Total= 6.00+1.00+0.75+0.50+1.00+0.75= Rs. 10.00 == MRP Printed on Soap

MPP Provision salient features

Product should cover both under Excise & L M Act

As per L M ACT certain goods, RP Printing is mandatory

MRP Less Abatement is value (Abetment % notified by CBEC)

More than one MRP in packet Highest MRP is value

MRP Scored out to show saving, it is not relevant

Goods removed with out MRP resulting Confiscation +CG determine value

MRP increased after Goods removed, Increased MRP is value

MRP Valuation not applicable in case of

Goods supplied to Industry(except cement), sold in bulk which are not for resale, +1, +2 free items ,sale to defense, pack less than 10 g & 10 ml , packed food items

Carton boxes containing 500 Sachets of Shampoo cannot be considered as Multi-piece Package for retail sale. MRP Valuation not applicable - *Kraftech Products 2008 (224) ELT 504 (SC)*.

MRP Valuation applicable only When declaration of MRP is required under law *Makson Confectionary Ltd (SC) 2010*

MRP Valuation not applicable: When ice cream sold in bulk/

, selling Kit Kat chocolates to Pepsi, these were distributed as a free gift along with a Pepsi bottle . *Jayanti Food Processing(SC)*,

When goods covered in MRP, CVD is payable on Imports on MRP Basic.

When goods covered in MRP, imported used for process, CVD payable on T V basis

Meaning of transaction value | Sec 4(3)(d)

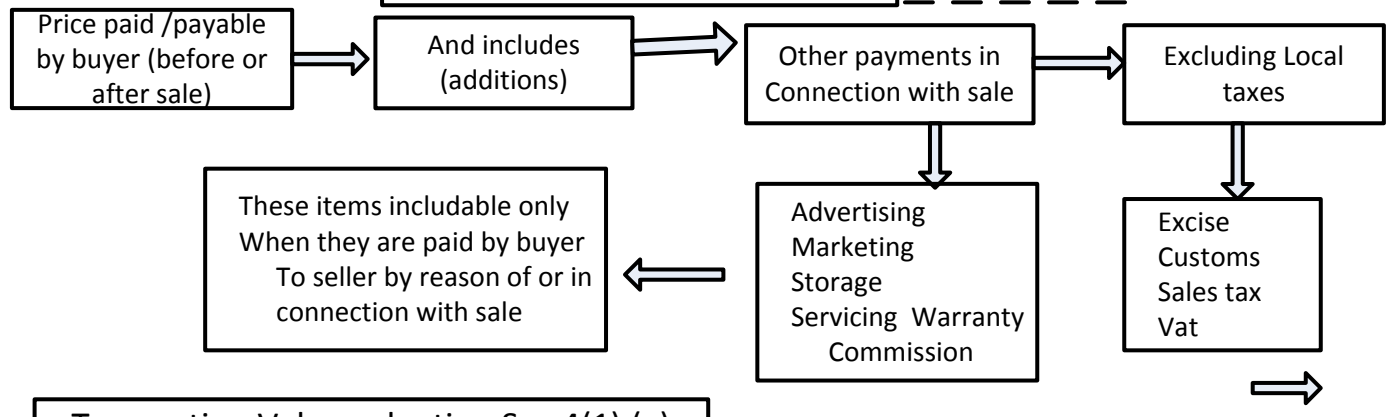

Transaction Value valuation Sec 4(1) (a)

Conditions

1. Price of the goods sold at the time and place of removal(Sale and delivery at the place of removal)
2. Buyer and Seller not related to each other
3. Price is a sole consideration for the sale

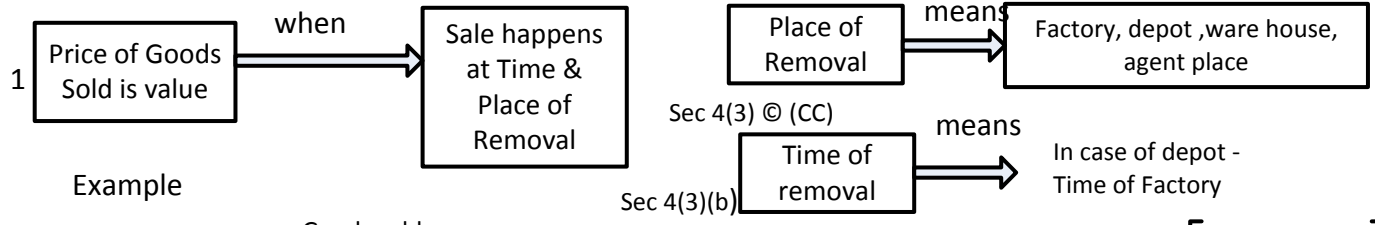

Example



Factory-Place of removal
 Goods sold on 30.03.2013 at 4 Pm, @ Rs.140 per unit + taxes+ transport +Insurance
 Sale complete at factory FOB Price at factory Rs.140 is value
 Exp. after removal not relevant for value
 Price increase after removal to 150. but before delivery to buyer. No Escalation clause in order. buyer not paid the same
 Original order cancelled and deliver the same to other buyer at Rs. 130. without getting back to factory.
 Rs.140 is value Rs. 130/ Rs.150 not relevant

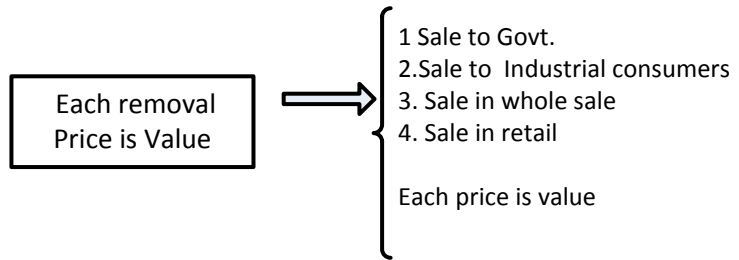
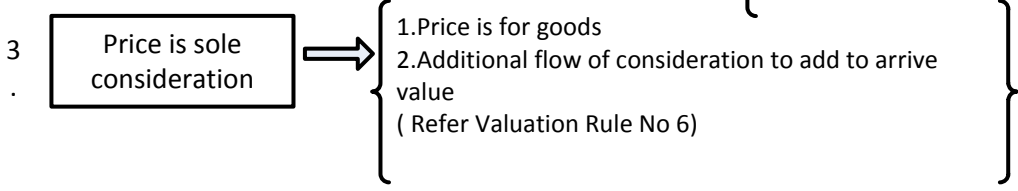
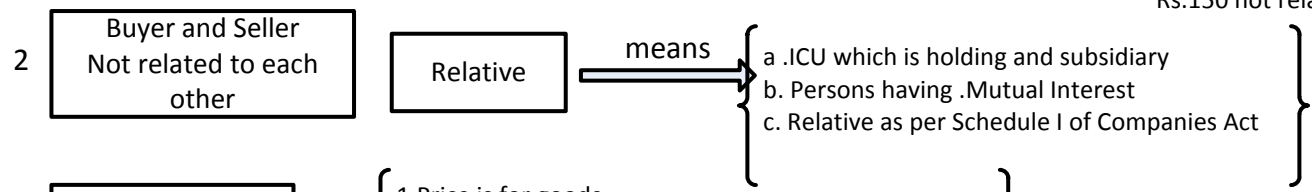

Read
 Simplified Approach to IDT, By CCH Publishers,gurgoan
 3rd edition for May 2013
 Available in all leading book stalls
 Online stores:
 indiaccstores,lawbookshop.net,jainbookdepot.com,flipkart.com

Inclusions and Exclusions in Valuation

Inclusions in Value

1. Exp. Incurred with in place of removal-loading coolie et
2. Packing(Primary),
2. Secondary, special Packing, if goods are removed from factory in that packing for whole sale trade. National leather (SC)
3. Salesman commission
4. Warranty, after sales service.(Optional extended warranty Not incudable- Maruthi udyog (SC)
5. Inspection charges- if mandatory before sale
5. Instllation & Erection in case of movable goods not removed from factory and installation bring in to existence of goods (Ex. Movable furniture assembled at site)
6. consultancy charges for Manufacturing
7. Design, drawing and Engineering of goods
8. Hire charges for D & R packing

Include all above only if they are not included in price

Sec 4(3)(d) of CEA

Sale Price for goods	XXX
+ Addl. Recoveries	XXX
- Sales Tax	(XX)
- Other Taxes	(XX)
- Excise Duty	(XX)
Transaction Value	XXXX

Exclusions in Value

1. Installation & erection
2. All discounts if pass to buyer.
3. Prorate cost of durable packing if inbuilt in price
4. Notional Int. on deposits. if not affect price
5. Int., on receivables, bank charges
6. All Local taxes
7. Freight, insurance from place of removal to buyer place.
8. Advt, Sales promotion by buyer on his own
9. Subsidy received from Government (from buyer is includible)
10. Security deposit for D & R Packing
11. Other charges if no diversion of genuine price.

Exclude all above only if they are included in price

Excise Valuation Rules

Value under Rules applicable only When any 3 conditions of T V is not fulfilled
(1. Goods not sold at the time and place of removal 2. Price is not sole consideration
3. Buyer and seller is relative)

Valuation when goods are not sold (Samples/Free warranty claims)- Rule 4

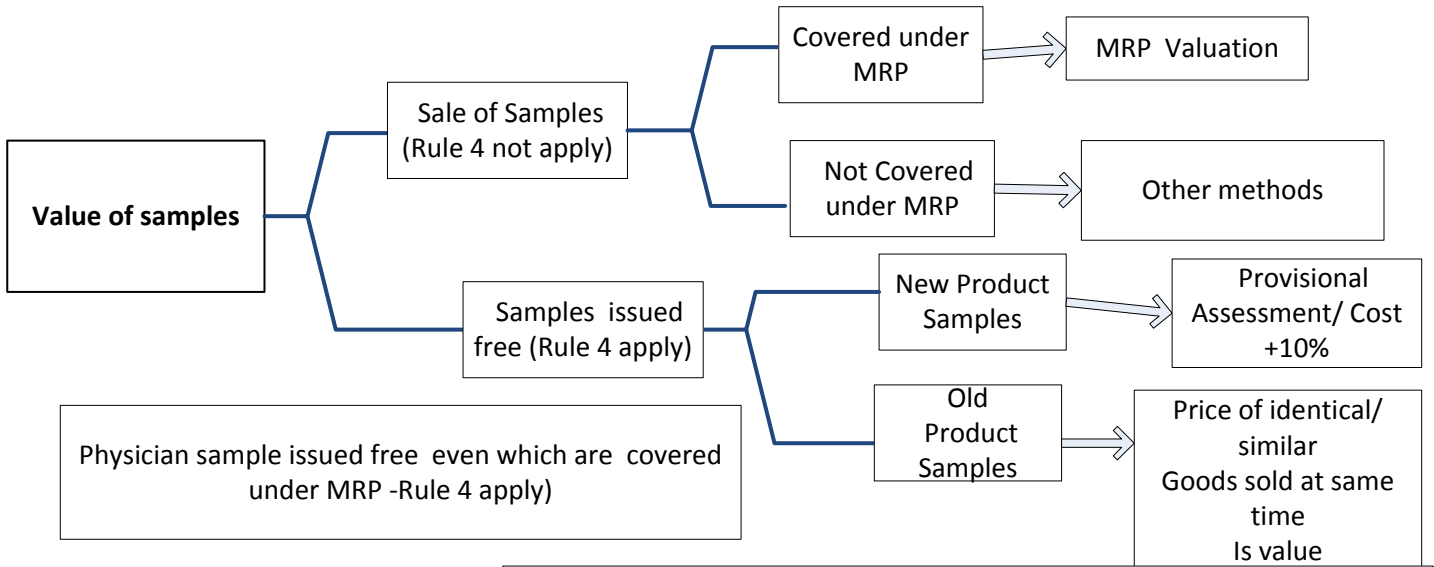

CA N. Rajasekhar FCA, DISA (ICAI)
Chennai
9444019860,
rajdhost@yahoo.com

Value can be made at Whole sale price/, price of highest qty sold

If not available Price at the nearest time/ date subject to adjustment for time and delivery is value

Rule 5- Value when goods sold at place other than the place of removal (Free on Road Contract)

Value will be calculated by deducting freight from place of removal to the place of delivery

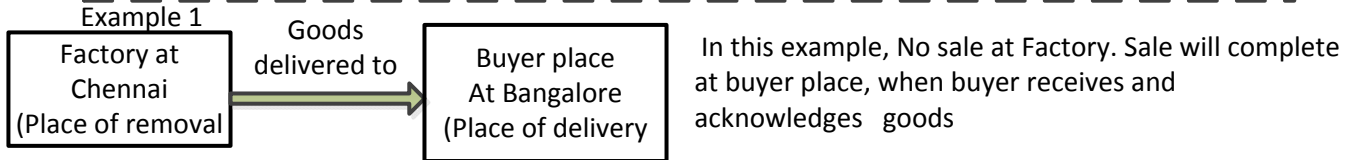

If, FO R price from Chennai to Bangalore is Rs. 120 per unit and freight from Chennai to Bangalore per unit Rs. 10, Value per unit will be Rs. 110 (120-10)

Freight deduction on actual basis or average basis (Explanation 1)

Example 2

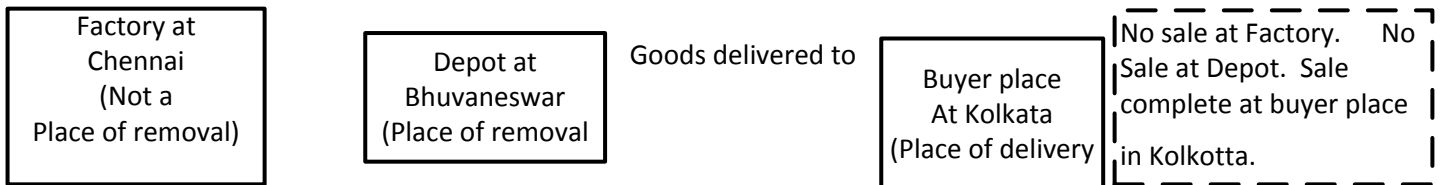

If, FO R price from Chennai to Kolkata is Rs. 200 per unit and freight from Chennai to Bhuvanewar is per unit Rs. 20, and freight from Bhuvanewar to Kolkotta is Rs. 10 Per unit Value per unit will be Rs. 190 (200-10)

No deduction for freight from Chennai to bhuvanewar as Chennai is not a place of place of removal (Explanation 2)

Rule- 6 Value, When the Price is not Sole consideration

Value = Amount paid by buyer + Additional Consideration flown to seller

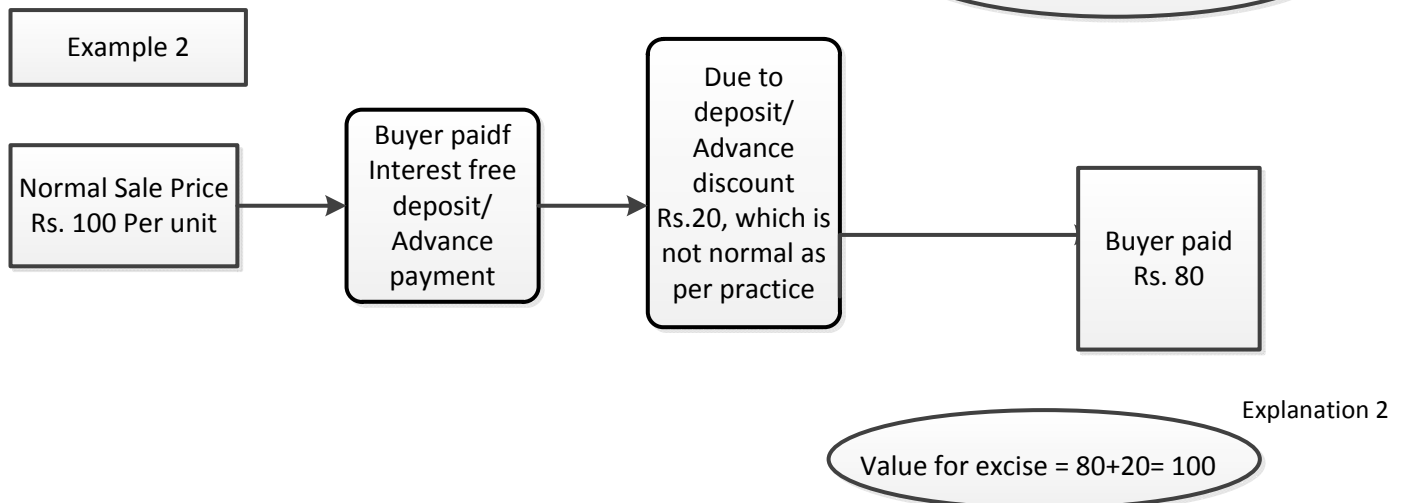
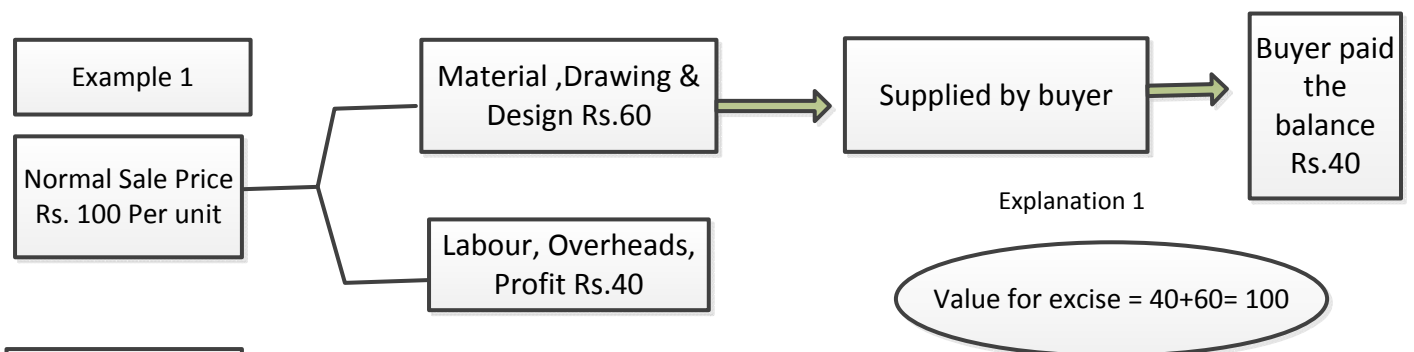

Valuation Rule No 7- Valuation in case of depot sale(goods transported from factory to depot/Other place & sold to buyer from that place of removal goods)

Value: Normal transaction value (price of Highest qty., sold) of depot on the date of removal from factory

Example

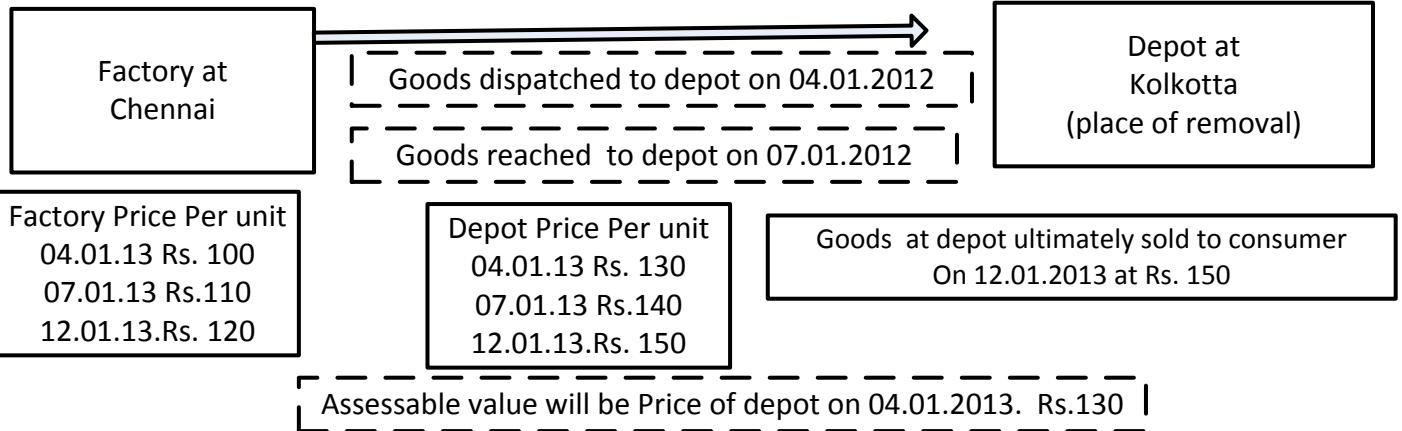

Note:

- 1.No deduction for freight from factory to depot
- 2.Freight and insurance from depot onwards is not includible in value.
3. Price at which such goods are subsequently sold to buyer from the depot is not relevant for purpose of excise valuation

Valuation Rule No 8- Valuation in case of Captive Consumption

Captive consumption means excisable goods are not sold by the assessee but are used for consumption by him or on his behalf in the production or manufacture of other articles

Value = Cost of production + 10% or 110% of cost of production:
Cost of production is to be calculated as per CAS 4

Cost of production as per CAS 4

- 1.Material consumed (net of tax)
- 2.Direct wages/ salaries
- 3Direct Expenses
- 4.Works OH
- 5.Quality control Cost
- 6.R & D cost
- 7.Admn.overheads relating to Production
- Less: Recoveries from Waste/Scrap
8. Packing cost

Indirect taxes Classes at Chennai and Bangalore

Chennai: Premier Academy Mylapore
044-24622694 / 9841661405
Bangalore: Shraddha academy
Rajaji Nagar, Bangalore
9141 888 592
23420603

Ignore Selling and distribution costs

Valuation Rule No 9 & 10- Value when the goods are sold to Relative

Applicable only

1. When all goods are sold to Relative person or through relative person
2. When Substantial qty., sold to relative person

Not Applicable

1. When the price at which goods sold relative person and un-relative person is same
2. When part of goods sold to relative and part of good sold to un-relative (Applicable rule Rule 11 BOJ)

Value: Price at which the related person sells to unrelated person.

CA N.Rajasekhar FCA,DISA(ICAI) Chennai
9444019860, rajdhost@yahoo.com

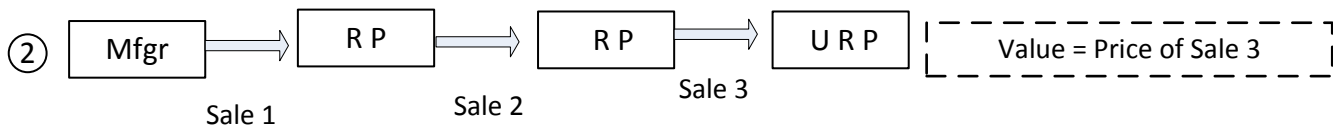
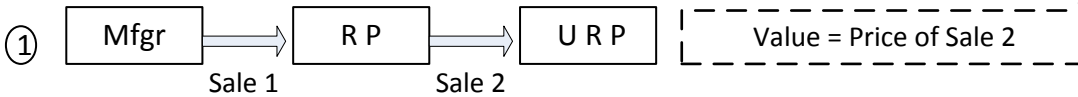

Where R P does not sell(Captively consumes) , Value is as per rule 8 -110% CPO of Mfgr.,

Valuation Rule No 10A. Valuation in case of job work

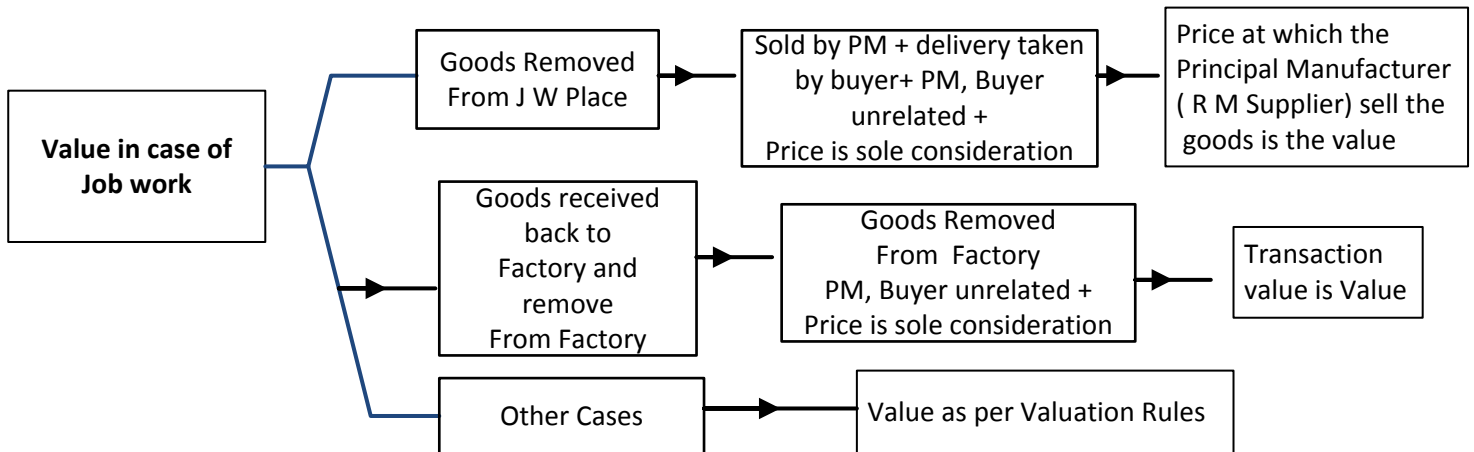

If goods manufactured by Job worker covered under MRP, Valuation will be on MRP basis not under Job work basis

Valuation Rule No 11. best of judgment method

Applicable

1. When all other rules not applicable
2. When part of goods sold to relative and part of goods sold to un-relative

Value: Combination of TV and all other rules with the available information.

CA N.Rajasekhar FCA,DISA(ICAI) Chennai, 9444019860, rajdhost@yahoo.com

Valuation Miscellaneous Topics

Valuation in case of computer
Acer India (SC)

- Value of preloaded operational software not includible in valuation in case of computer
- Not includible even computer cannot function without software.
- Software is not a part of Computer
- Computer is complete without software. CCE Vs Acer India Ltd (2004) (SC) 172ELT289

Valuation in case of Purchased parts and components

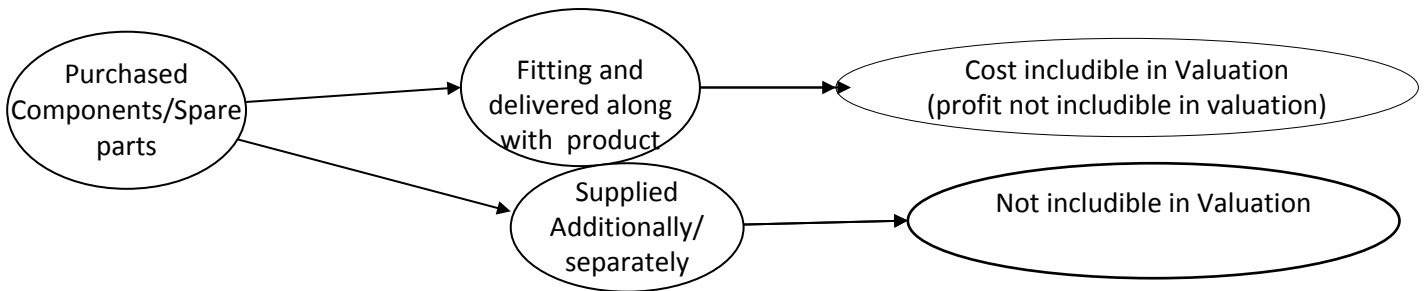

Valuation in case of Consumables

CA N.Rajasekhar FCA,DISA(ICAI) Chennai
9444019860, rajdhost@yahoo.com

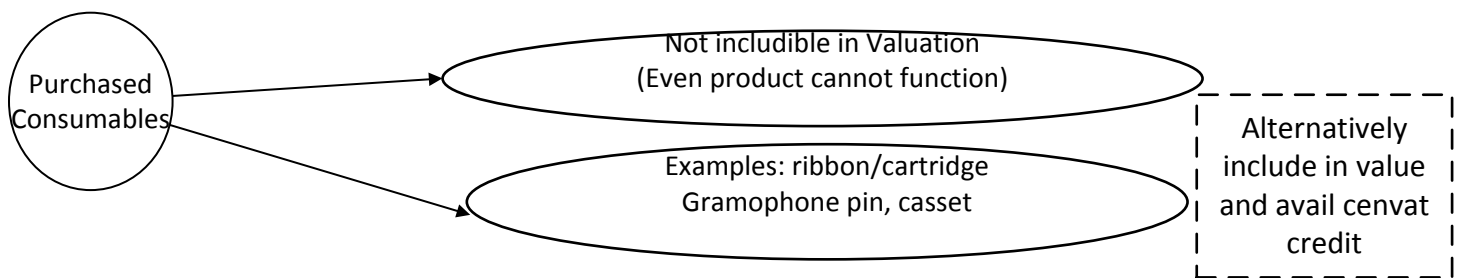

Accessories Which are optional not includible in Valuation

Cum duty Price (Price inclusive of duty)

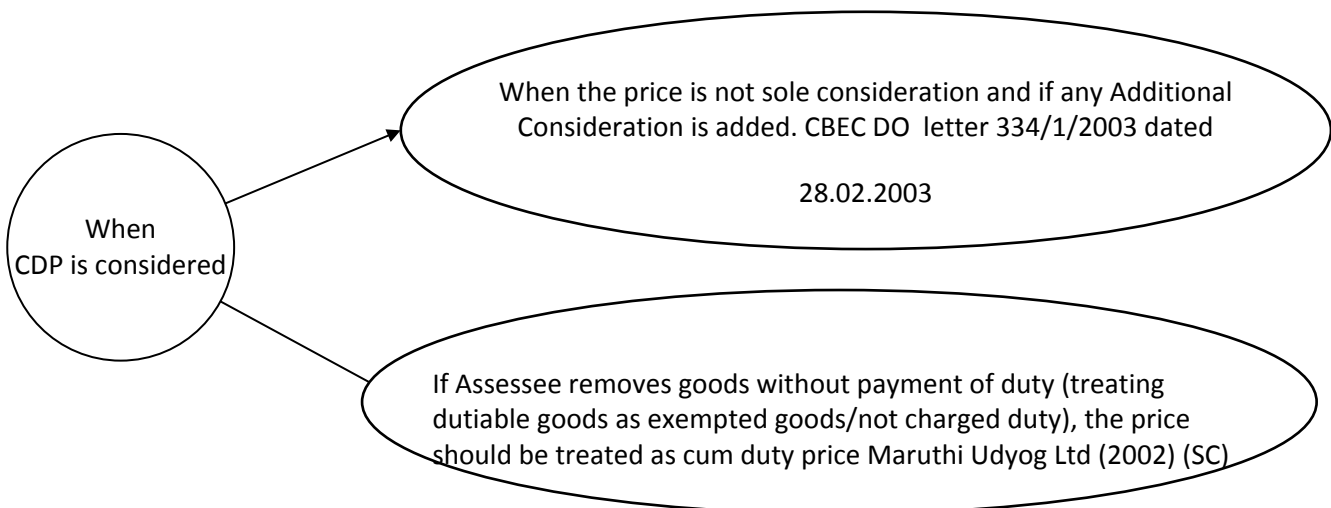

Av in case of CDP = $CDP \times \frac{100}{100 + \text{rate of duty incl. ec}}$

CA N.Rajasekhar FCA,DISA(ICAI) Chennai 9444019860, rajdhost@yahoo.com

Valuation Application/Order to follow

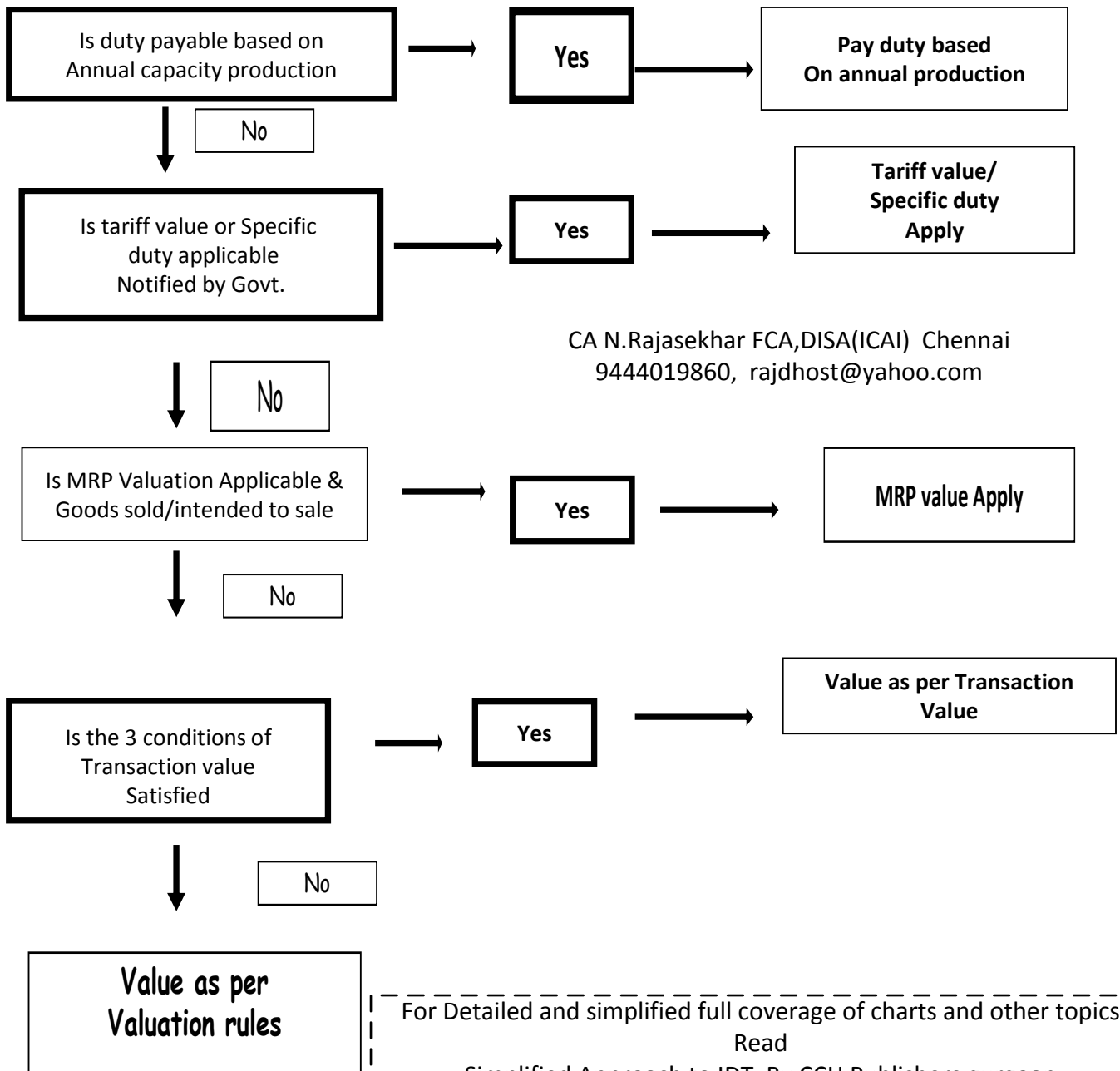

For Detailed and simplified full coverage of charts and other topics
Read
Simplified Approach to IDT, By CCH Publishers,gurgoan
3rd edition for May 2013
Available in all leading book stalls
Online stores:
indiacchstores,lawbookshop.net,jainbookdepot.com,flipkart.com

Cenvat Credit Basics

CENVAT Credit System

- Coverage CENVAT Credit Rules, 2004
- Rules provide integration of central excise and service tax.
- Credit can be taken by both manufacturer and service provider.
- Manufacturer can take credit for payment of excise duty and service tax.
- Service provider can also take credit for payment of service tax and excise duty.
- Credit is available for duty paid on inputs, Capital goods and service tax paid on input services used for manufacturing final product/ providing output services.
- The input should be used with in factory directly or in relation to manufacture.
- No input credit is available if final product/output service is exempt from duty / service tax.
- CENVAT Credit Rules do not require input-output correlation to be established.
- Credit is available for specified duties.
- Credit of excise duty and/or service tax can be availed only on the basis of documents.
- Records need to be maintained and returns need to be furnished.

Timing of credit

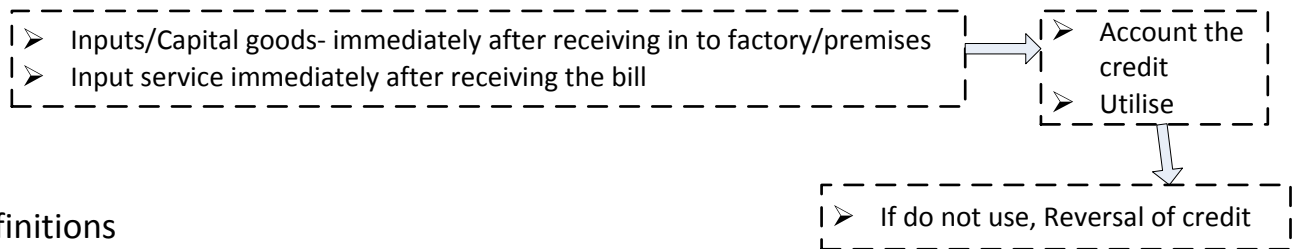

Imp Definitions

Exempted goods means:

- Excisable goods which are fully exempted from duty;/NIL duty goods
- 1% duty goods as per notification No 1/2011 if benefit availed & .
- Goods at serial numbers 67 and 128 of Notification No. 12/2012 & 21/2012 (Bitumen, fertilisers not used as a fertilizer)-.

Exempted service means:

- Negative list of Services where no service tax payable;
- Taxable services wholly exempted from tax;
- Taxable services whose part of value is exempted (Abatement applicable services)
- Exempted service shall not include a service which is exported in terms of rule 6A of the Service Tax Rules, 1994.

Output service means:

- Any service provided by a provider of service located in the taxable territory Output service shall not include a service,-
- (i) Negative list of services specified in Sec 66D of Finance Act 1994
 - (ii) Where the whole of service tax is liable to be paid by the recipient of service.

:

For Detailed and simplified full coverage of charts and other topics
Read
Simplified Approach to IDT, By CCH Publishers, gurgoan
3rd edition for May 2013
Available in all leading book stalls
Online stores:
cchindiastores.com, lawbookshop.net, jainbookdepot.com, flipkart.com

Cenvat Credit System for Manufacturer

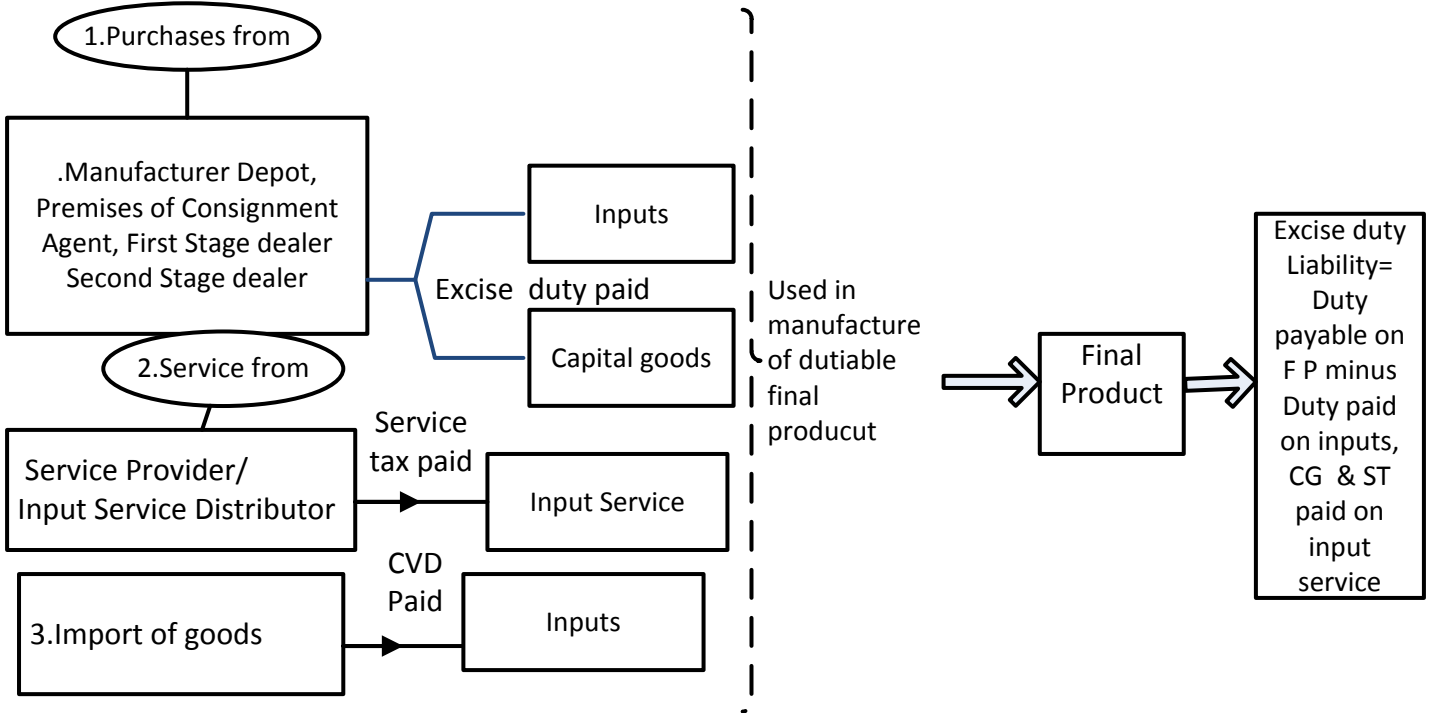

Cenvat Credit System for Service Provider

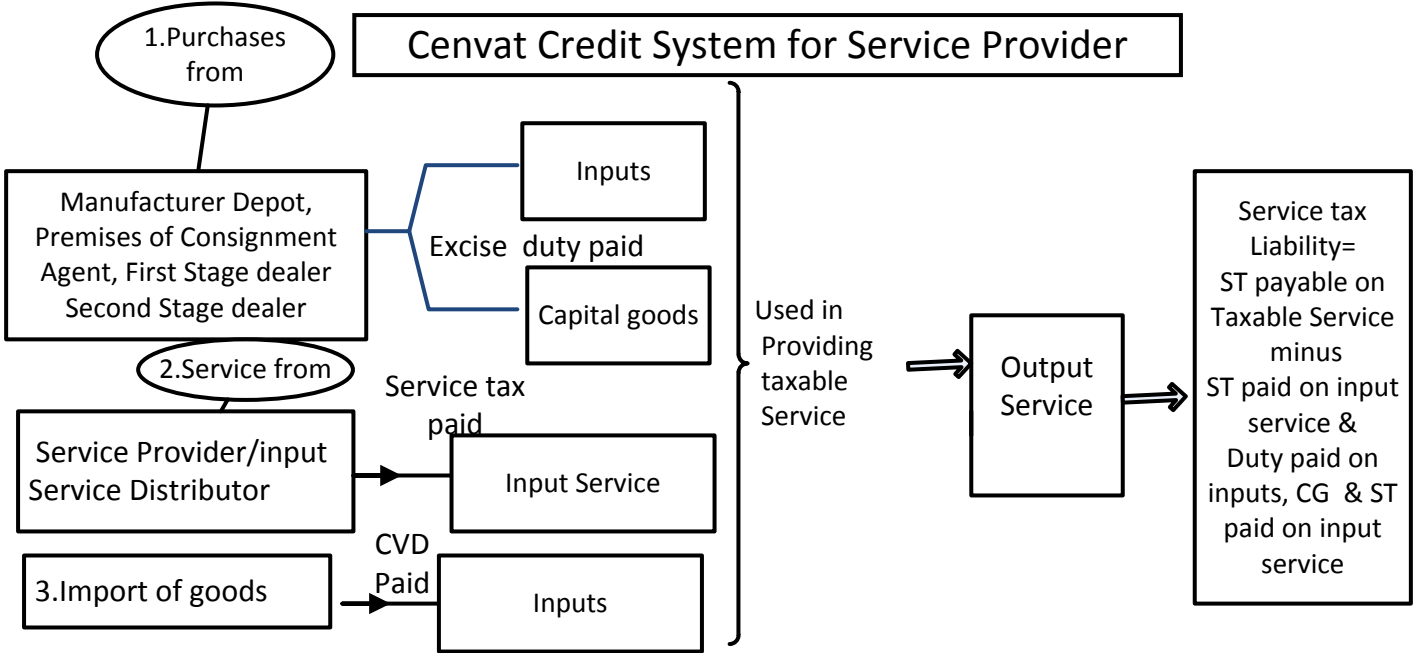

Quantum of Credit (Amount of Credit) Available

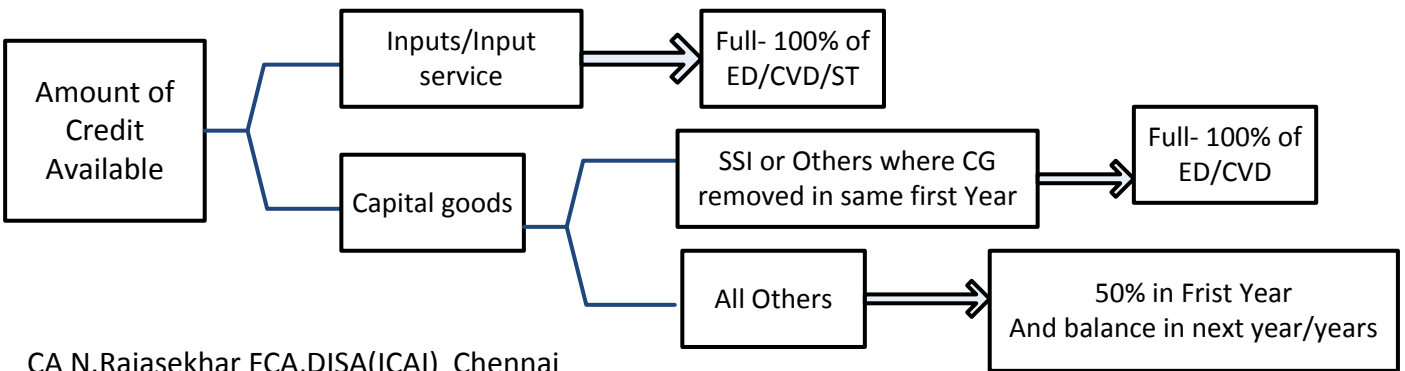

Inputs & Capital goods under Cenvat Credit

Example
Basic raw material,
Inputs used as fuel.
Consumables, packing
material, paints, label,
printing, branding

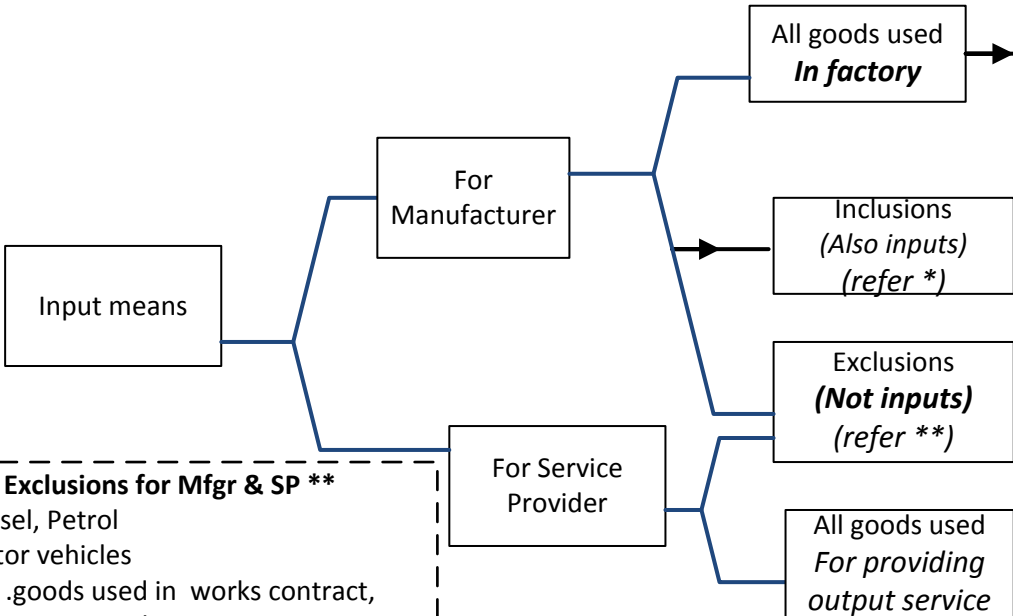

- Input Inclusions ***
- All goods including accessories cleared along with FP where Value includible in valuation.
 - Goods used for providing free warranty claims for final products (condition: warranty value is included in price)
 - All goods used for generation of electricity or steam for captive use
 - CG used as part/component in mfg., of FP

- Input Exclusions for Mfgr & SP ****
1. Diesel, Petrol
 2. Motor vehicles
 - 3 Any .goods used in works contract, construction , civil structure or part there of
 - 4..Any goods used for laying of foundation or making of structures for support of capital goods(Except provision of service portion in the execution of a works contract or construction service as listed in declared services)
 - 4.Any.goods are used primarily for personal use or consumption of **any employee**(used in guest house, club, quarters, food, clinic etc.,)

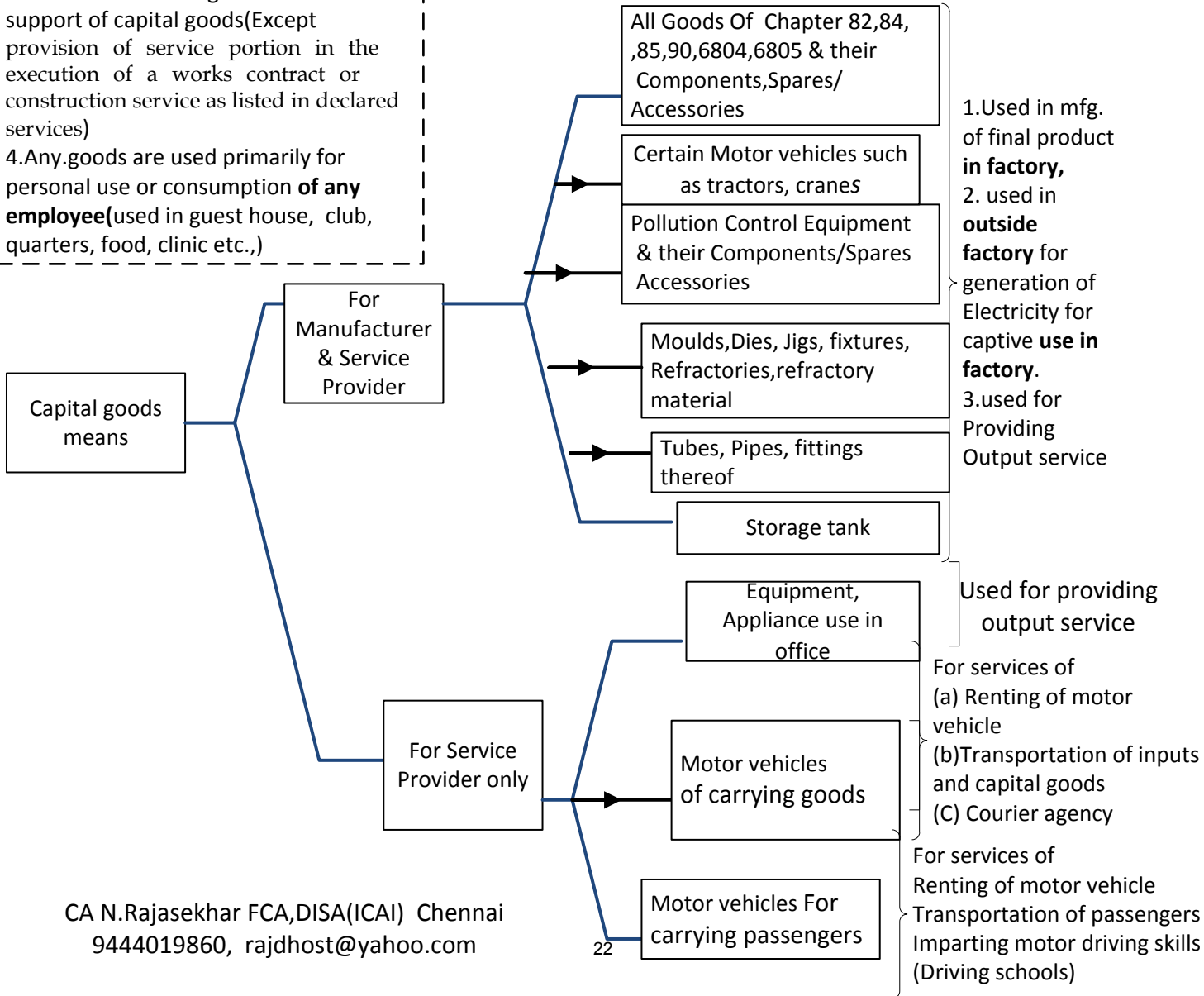

- 1.Used in mfg. of final product **in factory**,
 2. used in **outside factory** for generation of Electricity for captive **use in factory**.
 - 3.used for Providing Output service
- Used for providing output service
- For services of
(a) Renting of motor vehicle
(b)Transportation of inputs and capital goods
(C) Courier agency
- For services of
Renting of motor vehicle
Transportation of passengers
Imparting motor driving skills (Driving schools)

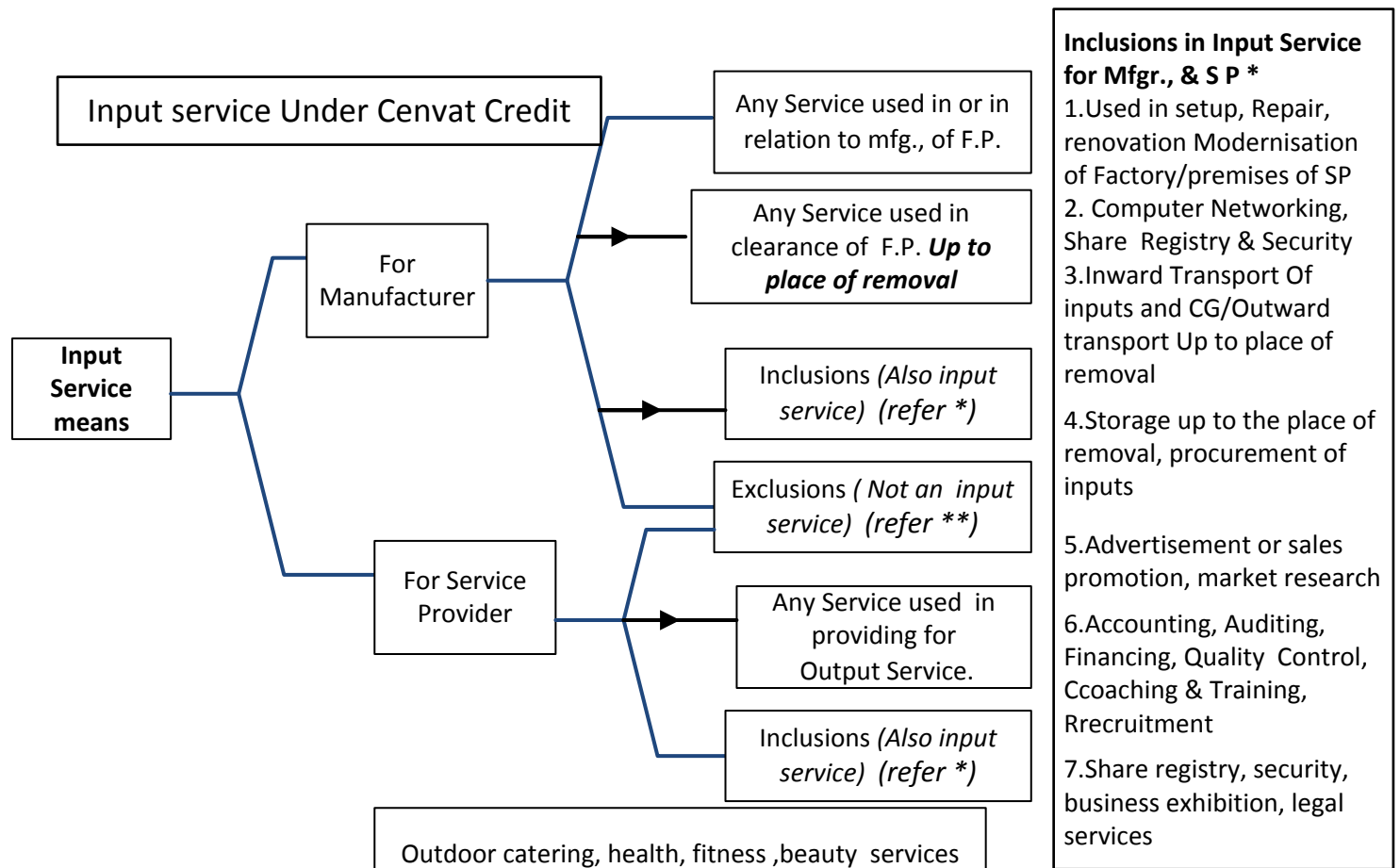

- Inclusions in Input Service for Mfgr., & S P ***
- Used in setup, Repair, renovation Modernisation of Factory/premises of SP
 - Computer Networking, Share Registry & Security
 - Inward Transport Of inputs and CG/Outward transport Up to place of removal
 - Storage up to the place of removal, procurement of inputs
 - Advertisement or sales promotion, market research
 - Accounting, Auditing, Financing, Quality Control, Ccoaching & Training, Rrecruitment
 - Share registry, security, business exhibition, legal services

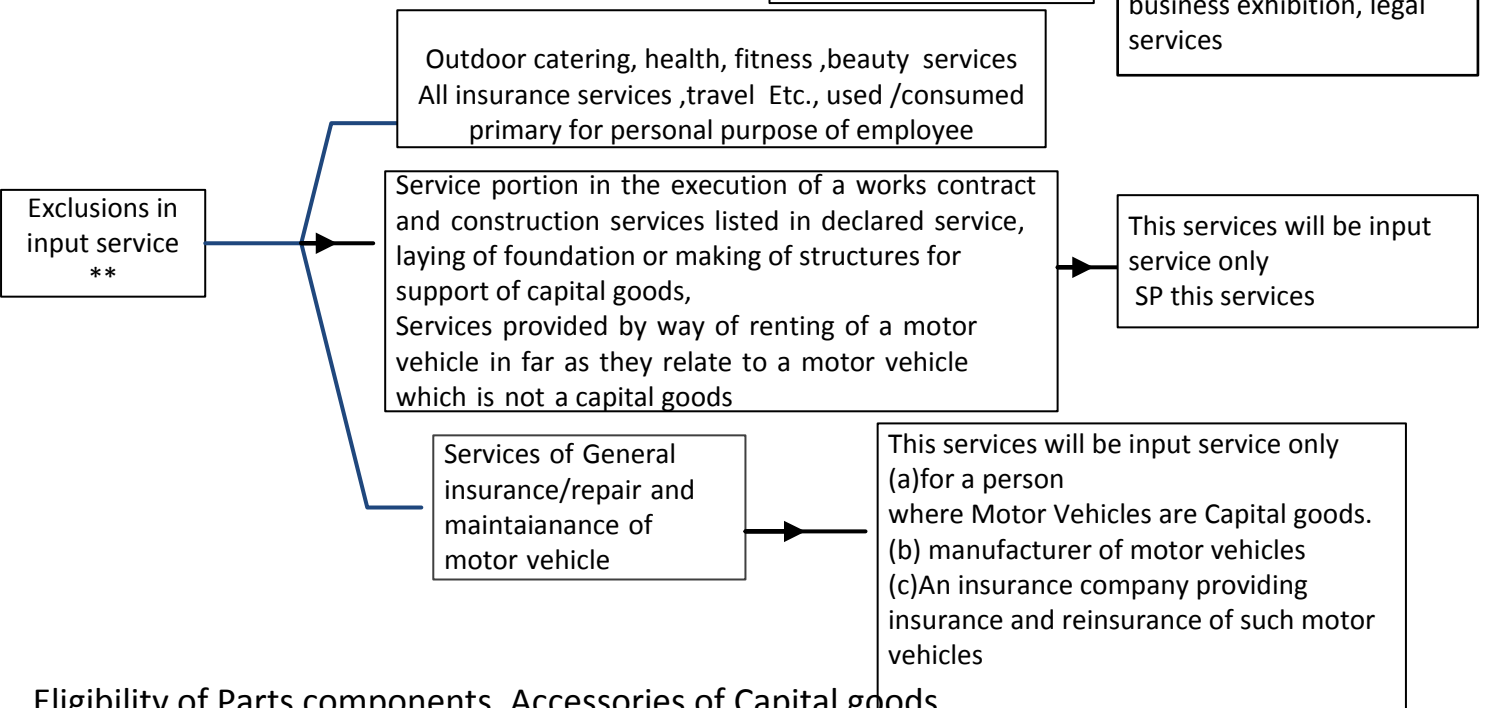

Eligibility of Parts components, Accessories of Capital goods

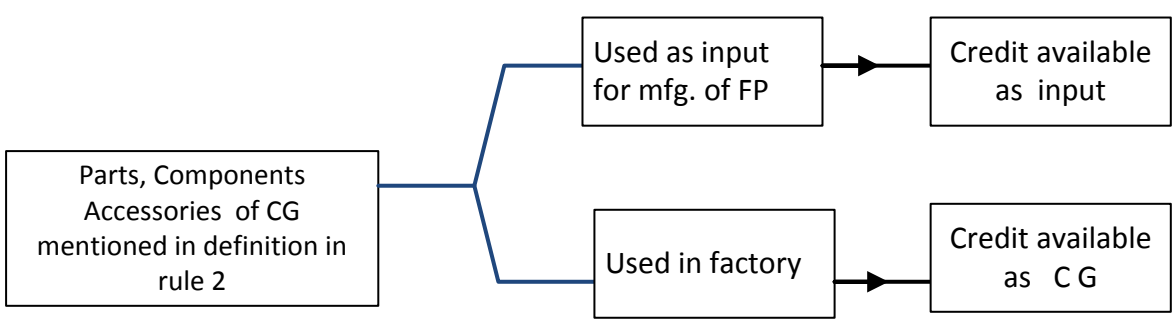

Parts, Components Accessories of CG not mentioned in definition in rule 2 if they are *Used as input for mfg. of FP* Credit available as input if it not in exclusion list.,

Cenvat Credit Rule No 3

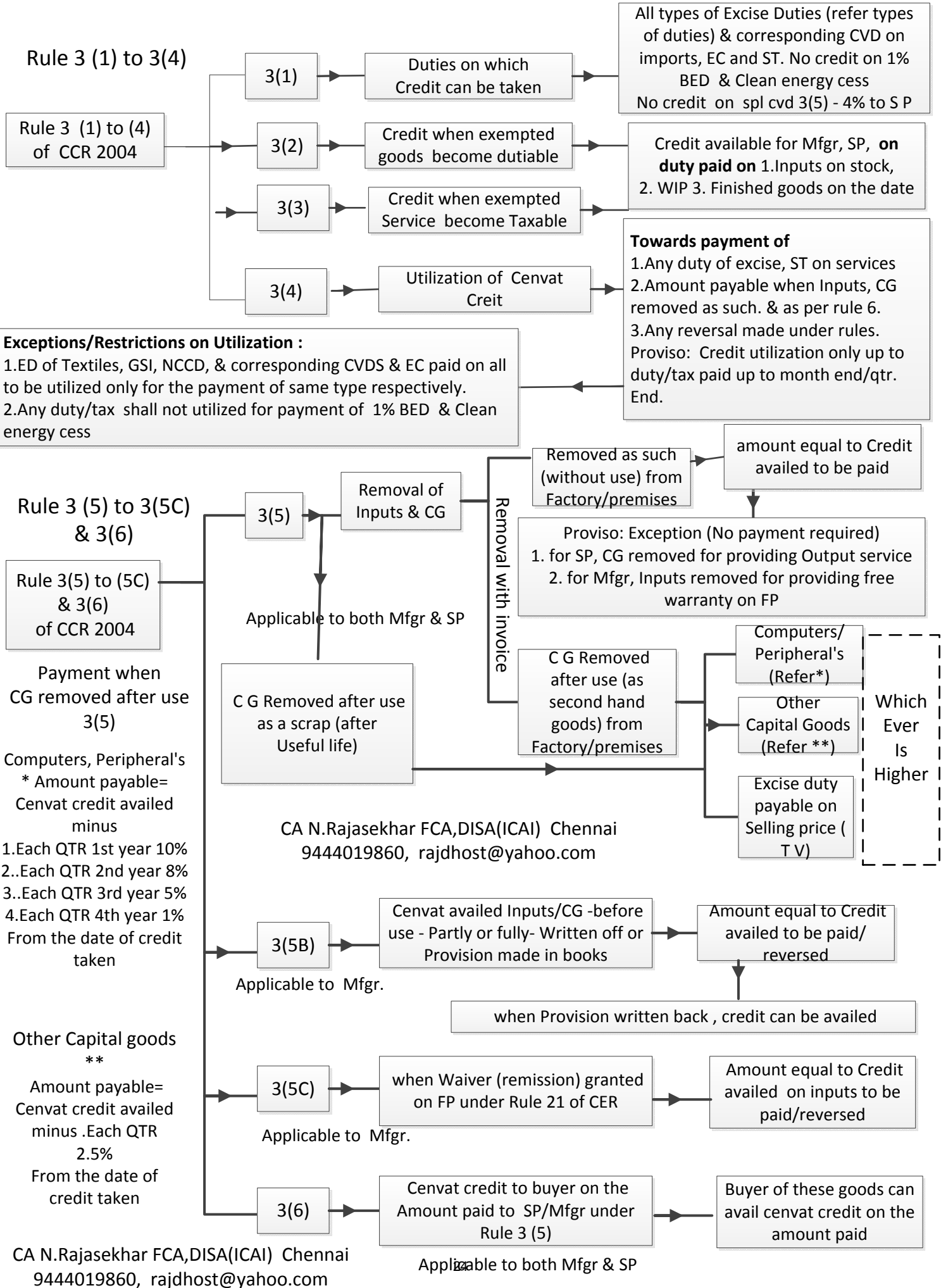

Cenvat credit Rule 3(7) & 4

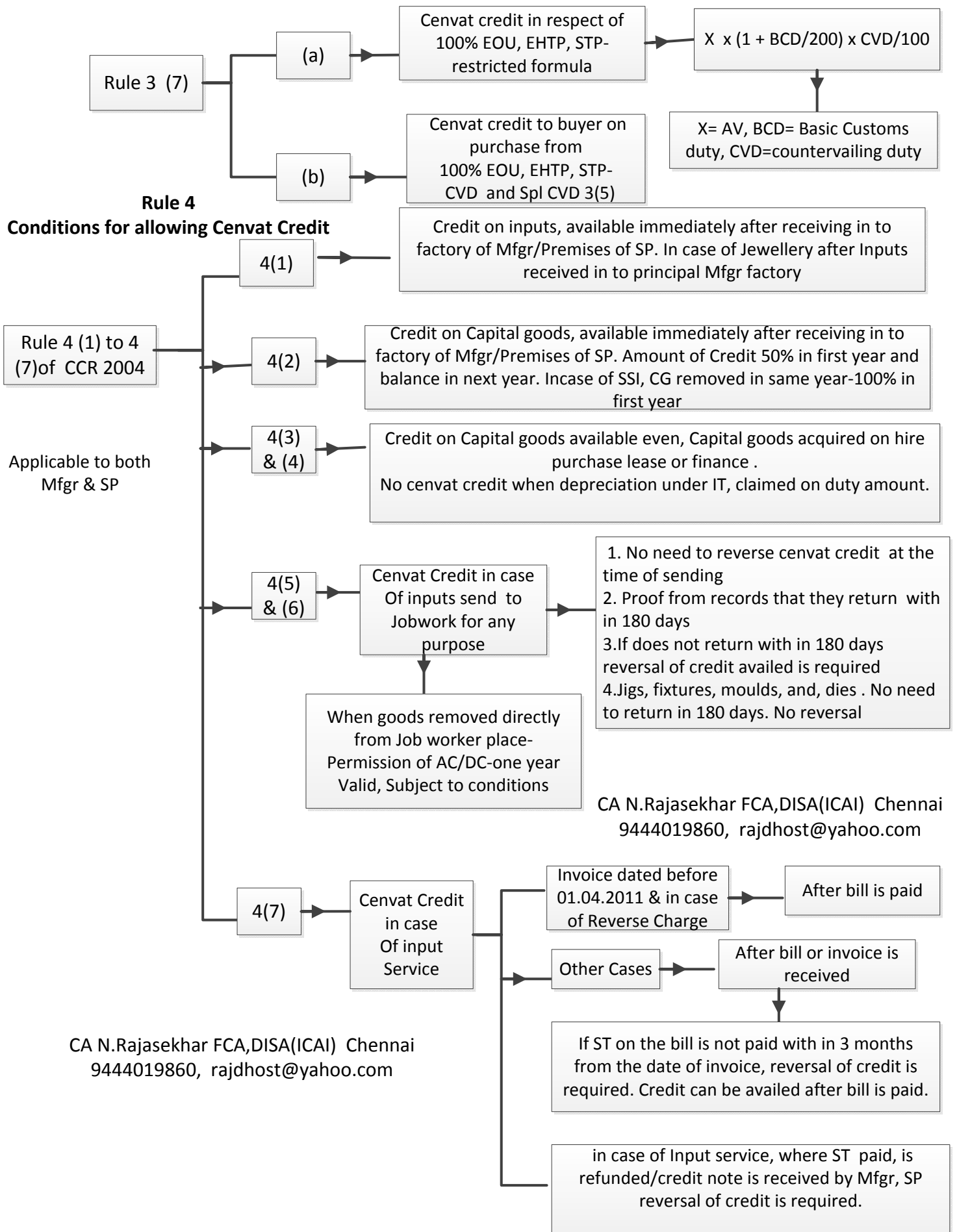

Rule 5 of Cenvat Credit Rules 2004-Refund of Cenvat Credit

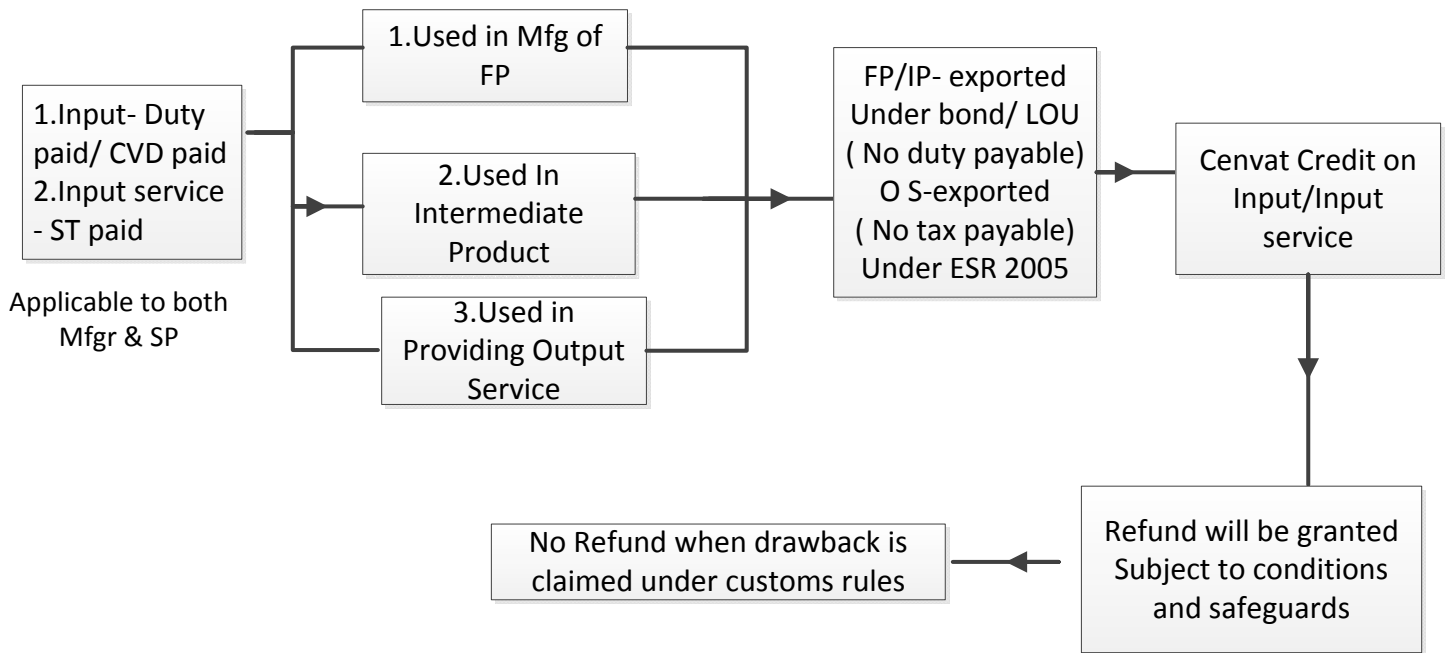

$$\text{Refund amount} = \frac{(\text{Export turnover of goods} + \text{Export turnover of services})}{\text{Total turnover}} \times \text{Net CENVAT credit}$$

Example 1

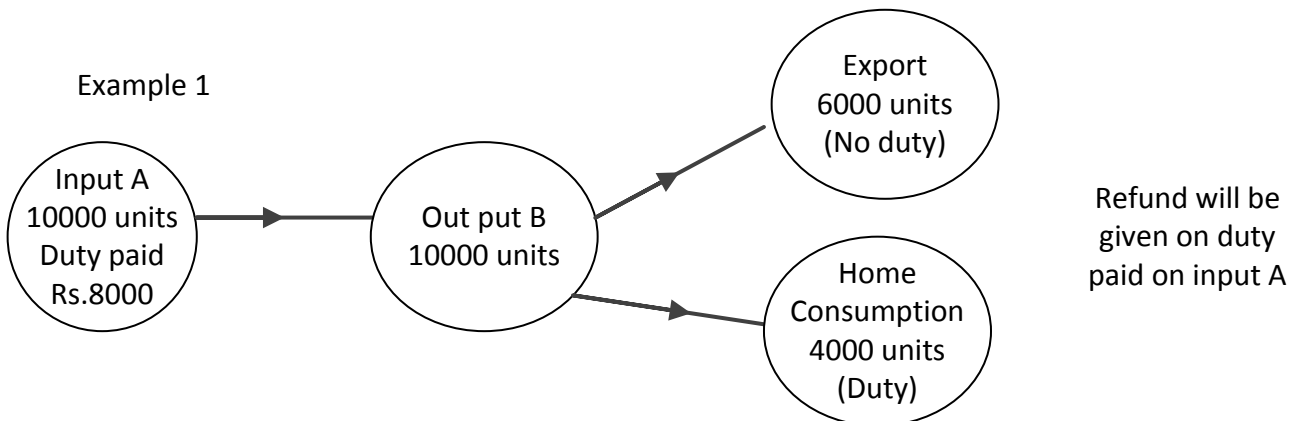

Example 2

CA N.Rajasekhar FCA,DISA(ICAI) Chennai 9444019860, rajdhost@yahoo.com

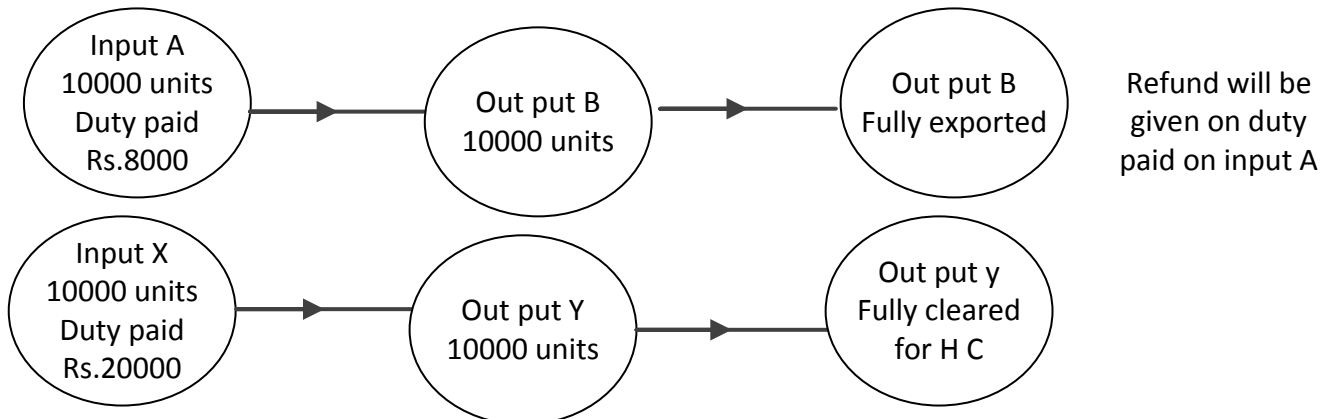

CA N.Rajasekhar FCA,DISA(ICAI) Chennai 9444019860, rajdhost@yahoo.com

Rule 6 CCR 2004-Obligation of a manufacturer or producer of final products and a provider of taxable service(Common inputs/input services for dutiable and exempted goods& taxable and exempted services)

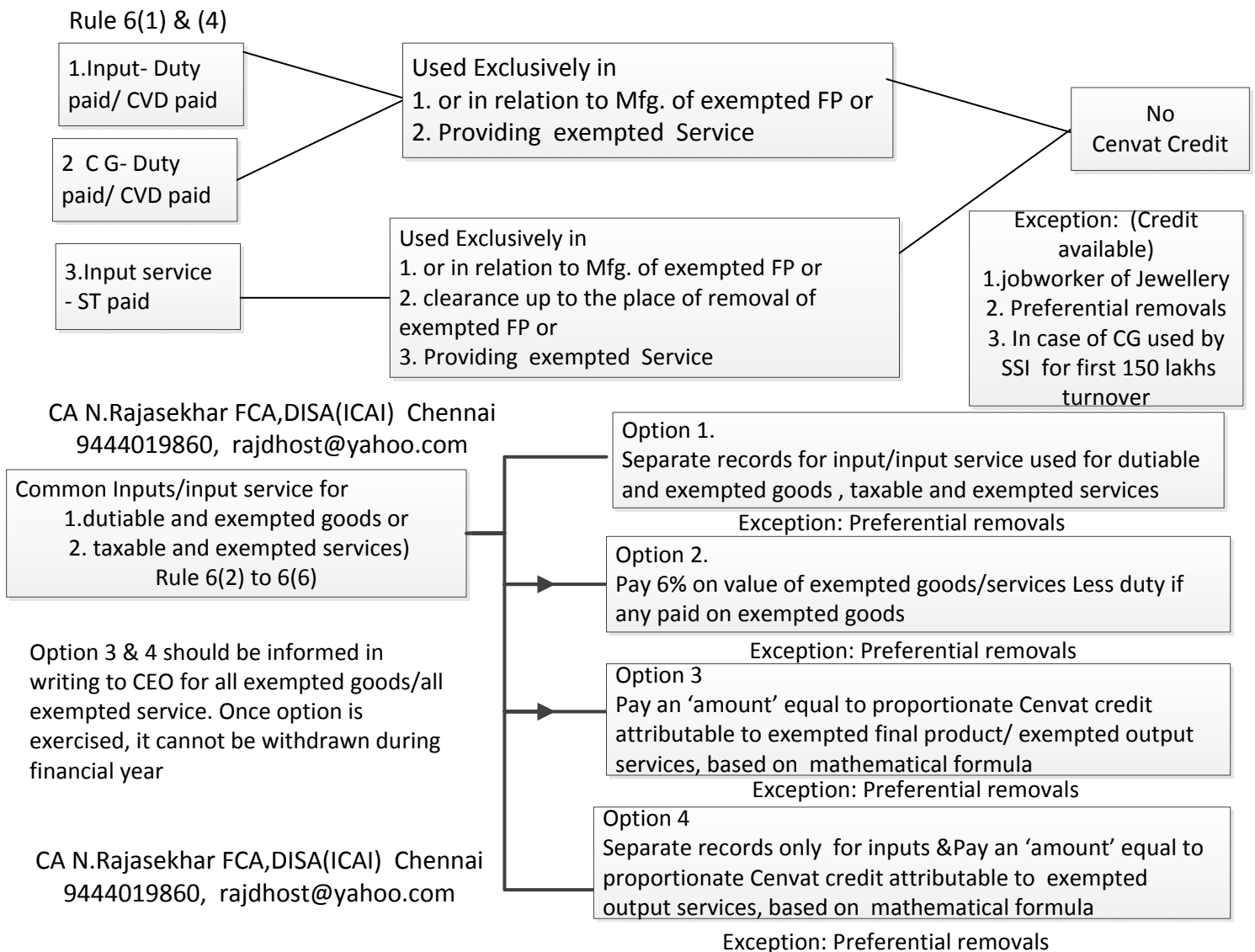

Preferential Removals :

- Final product is dispatched to SEZ unit or developer of SEZ unit, EOU, EHTP or STP/UNO, International Organization.
- When final product is exported under bond without payment of duty
- Gold or silver arising in course of manufacture of copper or zinc by smelting.
- Goods supplied against International Competitive Bidding
- Supplied for the use of foreign diplomatic missions or consular missions or career consular offices or diplomatic agents
- In case of taxable services provided , without payment of Service tax to SEZ or developer of SEZ for their authorized operation Rule 6(6A)-
- All goods which are exempt from customs BCD/CVD u/s 3(1)
 - (a) against International Competitive Bidding; or
 - (b) to a power project from which power supply has been tied up through tariff based competitive bidding; or
 - (c) to a power project awarded to a developer through tariff based competitive bidding, in terms of notification No. 6/2006-Central Excise, dated the 1st March, 2006

Rule 6(4)

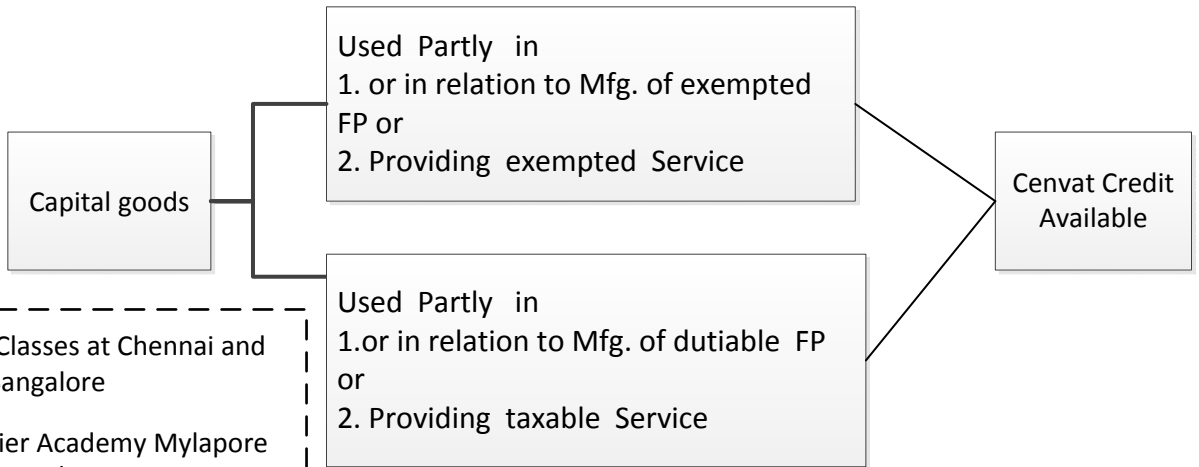

Indirect taxes Classes at Chennai and Bangalore
 Chennai: Premier Academy Mylapore
 044-24622694 / 9841661405
 Bangalore: Shraddha academy
 Rajaji Nagar, Bangalore
 9141 888 592
 23420603

Rule 7 Distribution of Credit by Input Service Distributor (ST on Bill distribution amount HO, braches, units)

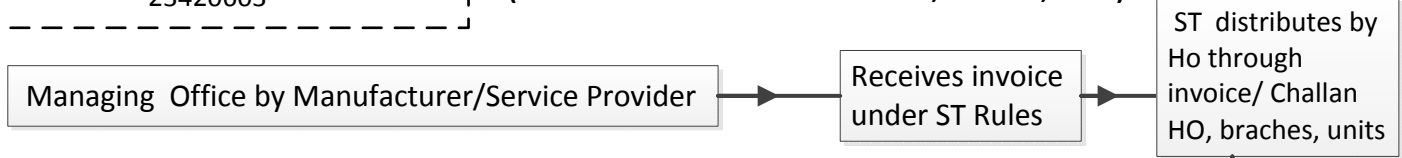

CA N.Rajasekhar FCA,DISA(ICAI) Chennai
 9444019860, rajdhost@yahoo.com

ST distribution should not exceed amount of ST Paid
 ST on service exclusively used for exempted service cannot be distributed.

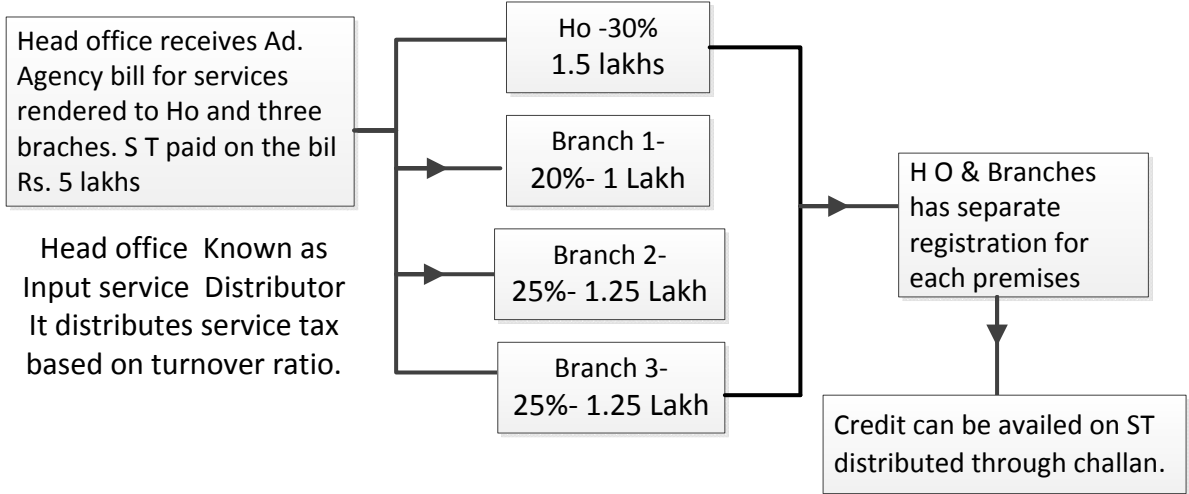

Rule 7 A Distribution of Credit of inputs/Capital goods by Input Service Distributor (Excise on Bill distribution amount HO, braches, units)

Same as Rule 7 instead of ST, it is ED paid on inputs/Capital goods
 Through invoice under rule 11 of CER

CA N.Rajasekhar FCA,DISA(ICAI) Chennai 9444019860, rajdhost@yahoo.com

Rule 8 of CCR 2004 Storage of inputs outside factory

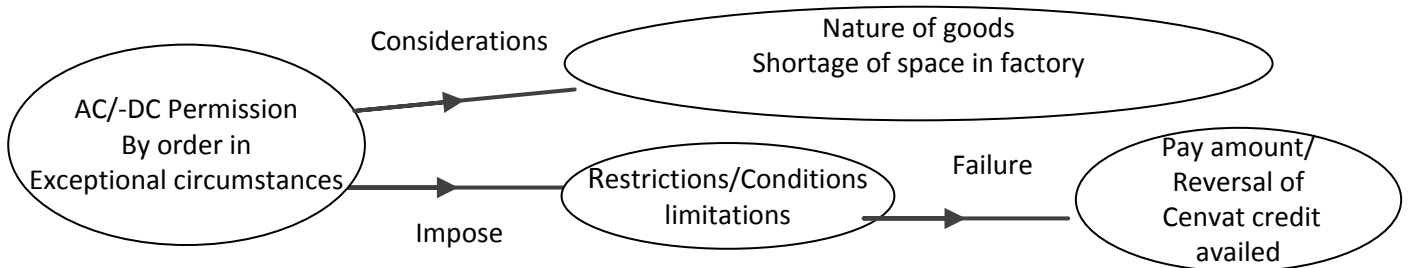

Rule 9 of CCR 2004- Documents and Accounts under Cenvat Credit

Documents for availing cenvat credit Rule 9(1)

For Excise/CVD

- An invoice of the manufacturer factory/deport/consignment agent place
- An invoice of the importer
- An invoice of the First / Second Stage Dealer
- A supplementary Invoice
- A bill of entry
- A certificate issued by an appraiser of customs in case of goods imported through post office

Prviso:

No credit on CVD 3(5)-4% if invoice/ supplementary invoice indicate no Credit available (When importer sell the goods paid Vat and want to claim refund of CVD)

Credit can also be availed on Any duplicate copy of invoice Photo copy of invoice/Any other document evidencing for duty or tax which is certified by CEO

For Service tax

- Invoice / bill / challan of the service provider
- Invoice / bill / challan of the input service distributor
- Supplementary invoice by Service provider except tax payable under extended period limitation cases
- Challan evidencing payment of service tax in case of reverse charge of ST

Particulars of documents 9(2)

1. All as per Rule 11 of CER
2. **Minimum Mandatory Particulars :**
 - If AC/DC satisfied goods/service received and accounted
 - a) Name and address of issuer of invoice
 - b) RC No.
 - c) Description of goods/service
 - d) value, Duty, tax

Cenvat Credit on FSD/SSD invoice Rule 9(4)

The invoice should indicate duty suffered or prorata duty suffered in case proportionate stock is sold

Records for cenvat credit Rule 9(5&6)

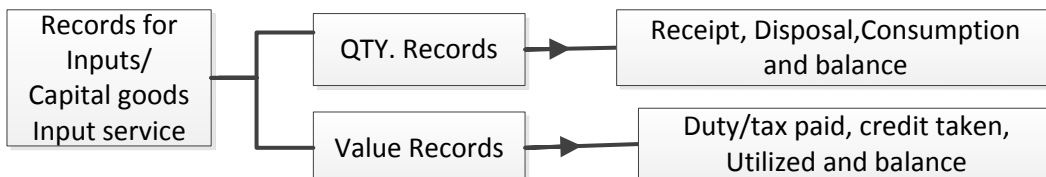

CA N.Rajasekhar
FCA,DISA(ICAI) Chennai
9444019860,
rajdhos@yahoo.com

Returns for cenvat credit Rule 9(7 to11) & 9A

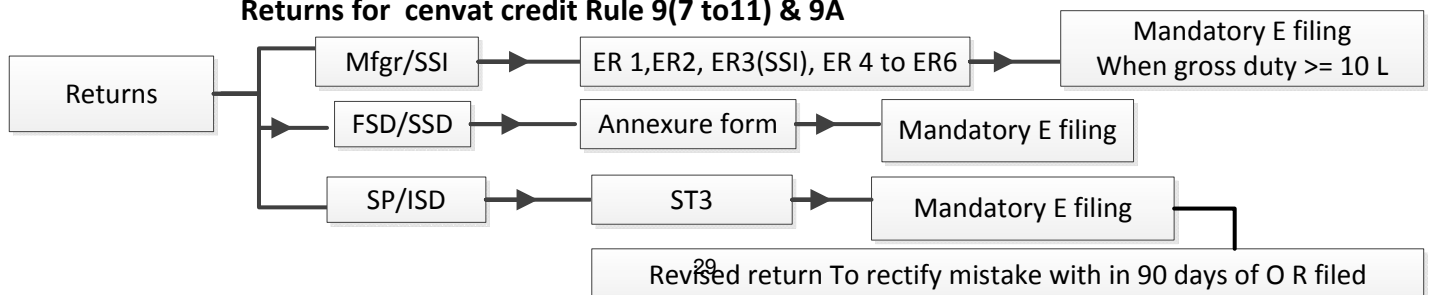

Rule 10- Transfer of Cenvat Credit

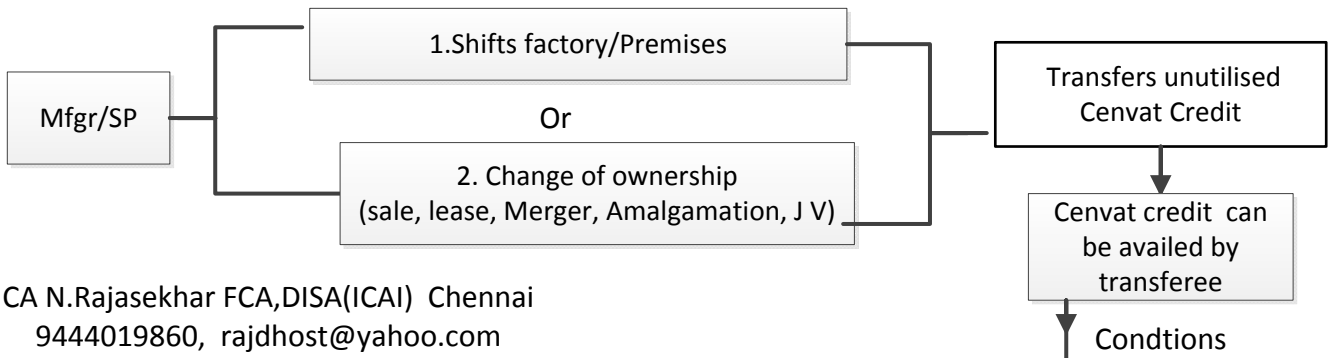

CA N.Rajasekhar FCA,DISA(ICAI) Chennai
9444019860, rajdhost@yahoo.com

1 Transferor transfers Inputs, WIP,CG with specific provision of transfer of liabilities .

2. Transferee Accounts Inputs, WIP & ,CG to the satisfaction of AC/DC

Rule 11- Transitional provisions of Cenvat Credit

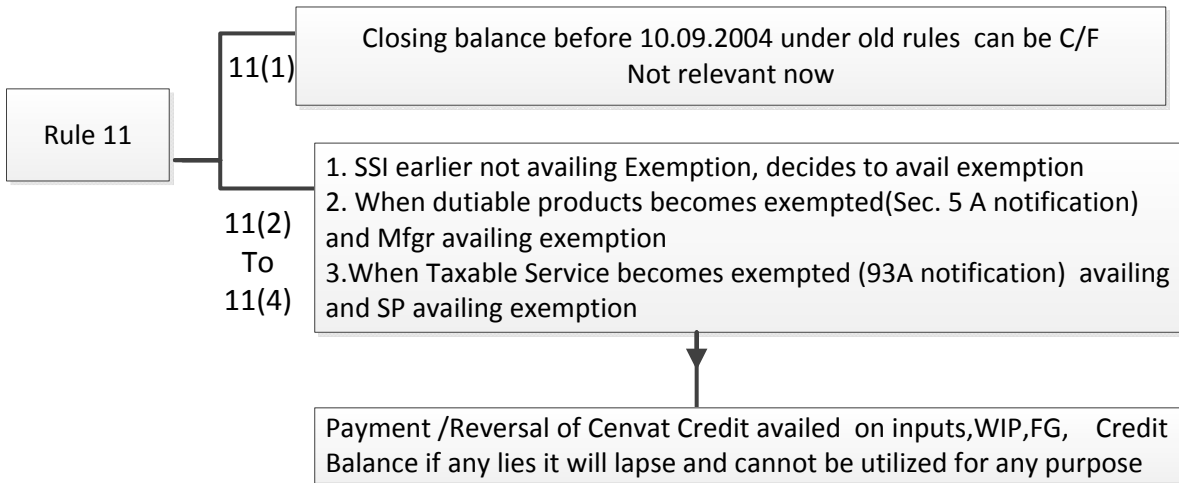

Rule 12- Full CC, if goods(inputs, CG) purchased from NE, J & K, Kutch in Gujarat, even duty partly exempted under notification

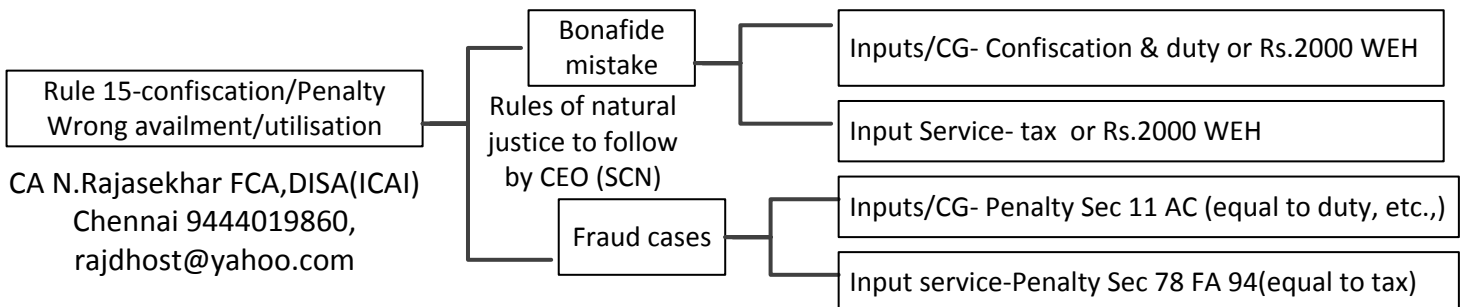
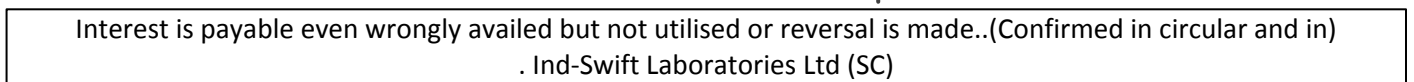
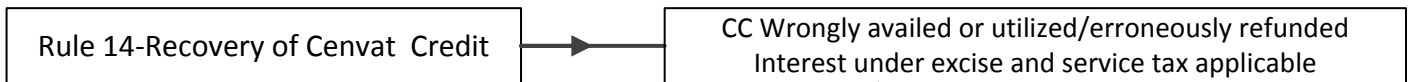
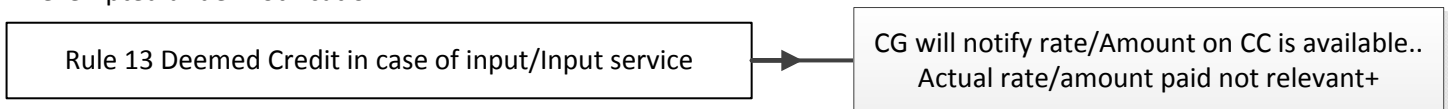

CA N.Rajasekhar FCA,DISA(ICAI)
Chennai 9444019860,
rajdhost@yahoo.com

Excise Registration- Sec 6/Rule 9/ Notification 35 & 36/2001

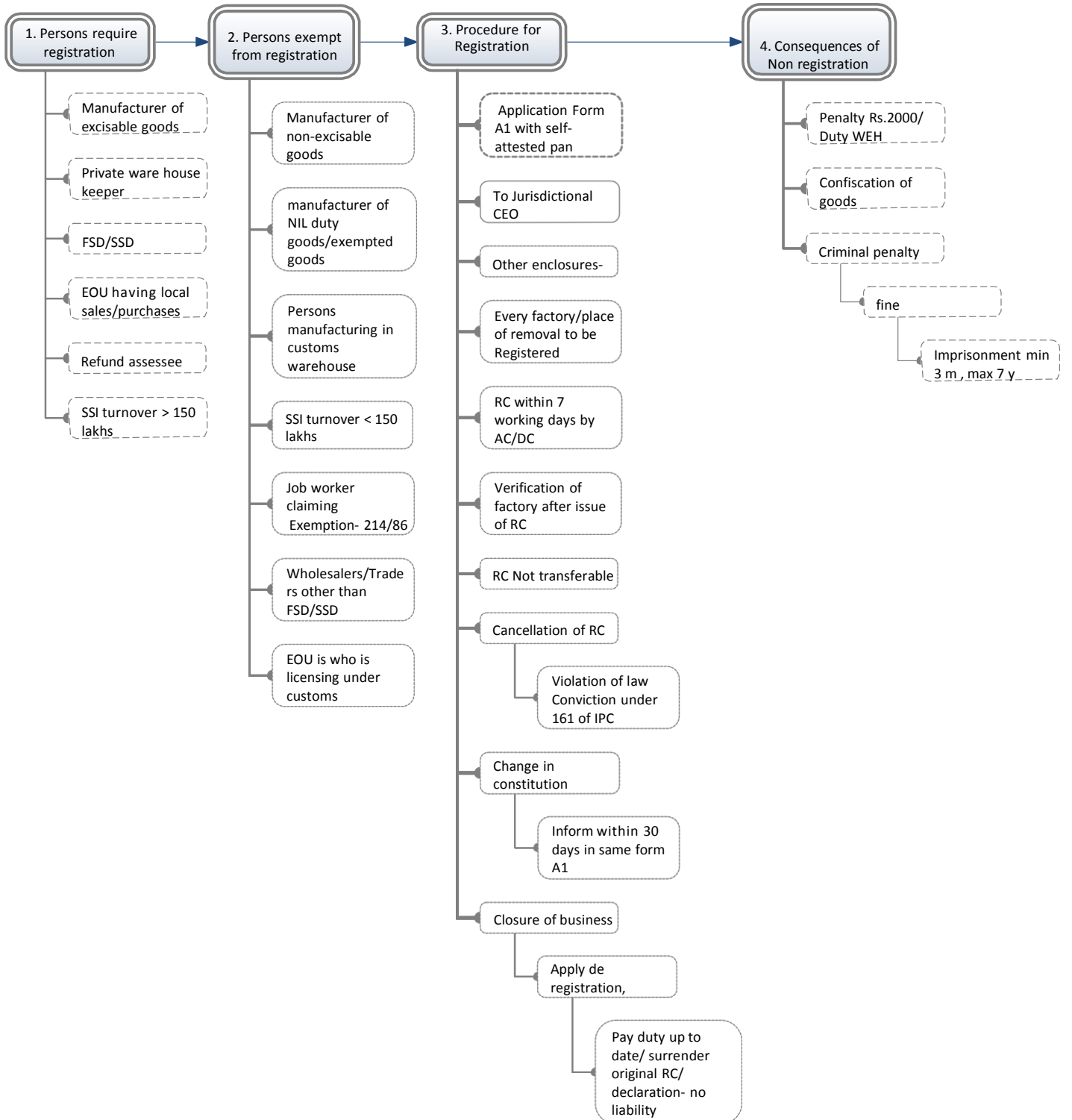

Procedure for Export of goods -Rule No18 & Rule No 19

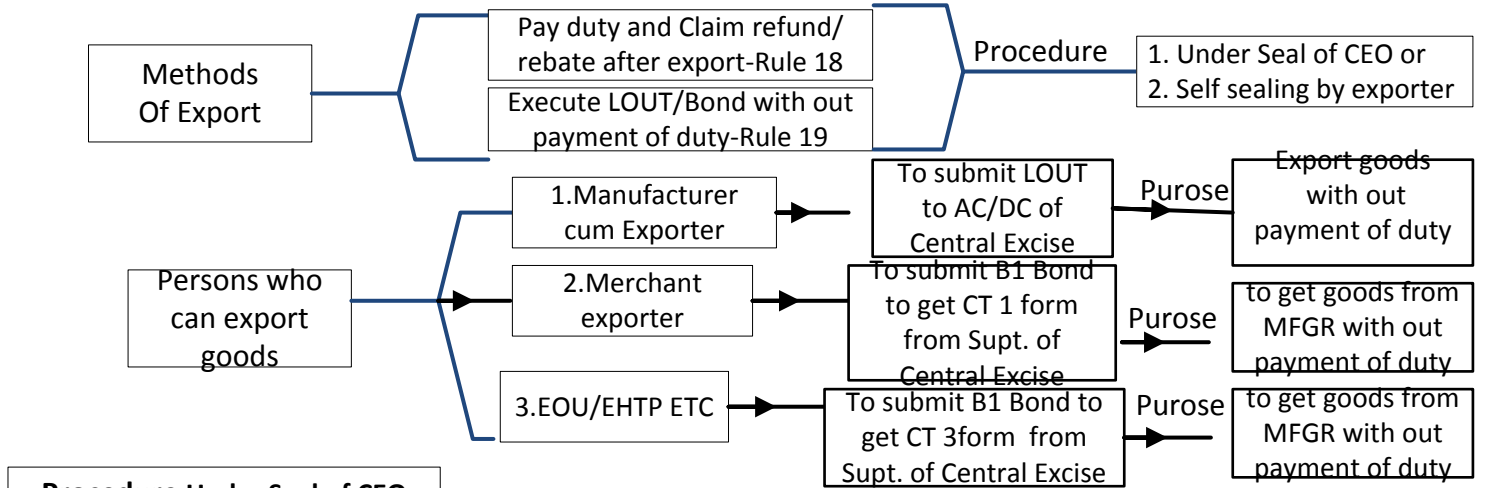

Procedure Under Seal of CEO

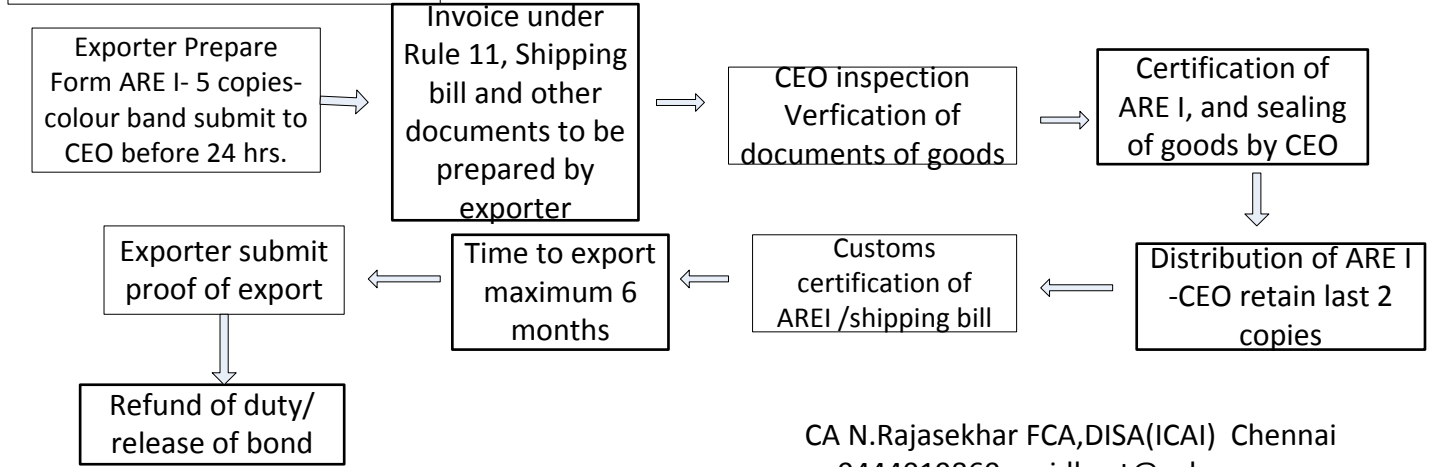

CA N.Rajasekhar FCA,DISA(ICAI) Chennai
9444019860, rajdhost@yahoo.com

Procedure Under self Seal By Exporter

Same as above except

- 1.ARE I to be submitted to CEO after 24 hours of export
2. Self sealing by exporter instead of CEO verification and certification in ARE I

Procedure for ware house goods -Rule No 20

Not all excise goods can be stored, Ware house registered under excise. Maximum period of storage 90 days.

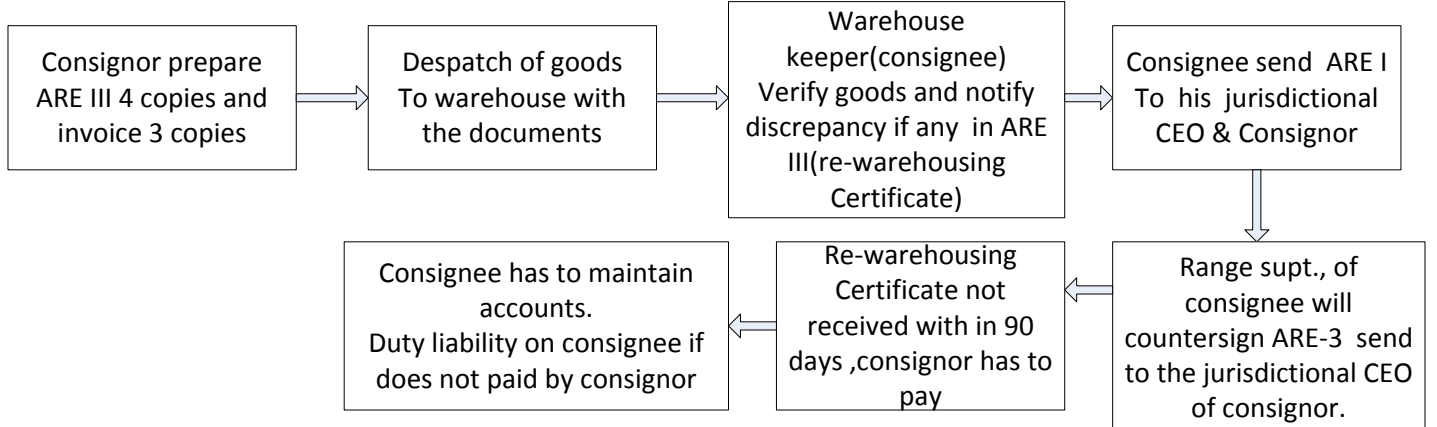

Read my book for
Other procedure Rule 8 duty payment, Rule 11 removal of goods for H.C ,Rule 16 to 16 C, Rule 17 & LTP
point wise simple self explanatory

Demand (Recovery) of Excise Duty- Sec 11 A of CEA

CA N.Rajasekhar FCA,DISA(ICAI) Chennai
9444019860, rajdhost@yahoo.com

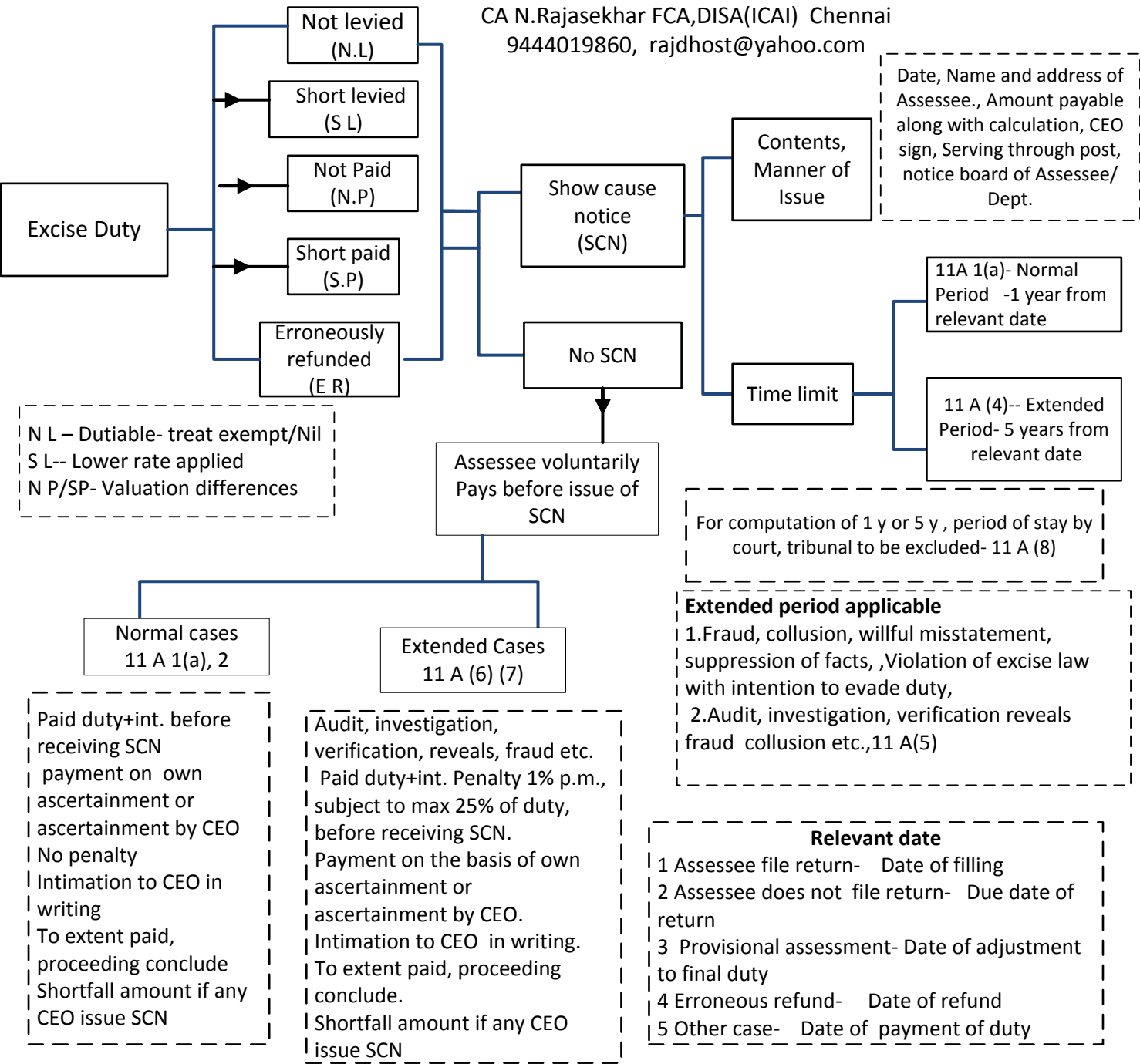

CA N.Rajasekhar FCA,DISA(ICAI) Chennai
9444019860, rajdhost@yahoo.com

SCN issued after lapse of time limit, it is invalid.
In case of extended period, it is on the part of department to prove fraud, collusion etc., on the part of assessee.

For Comparison with customs and service tax, read chapter 13 Division IV of the book

Adjudication orders of CEO- Sec 11 A(10) of CEA

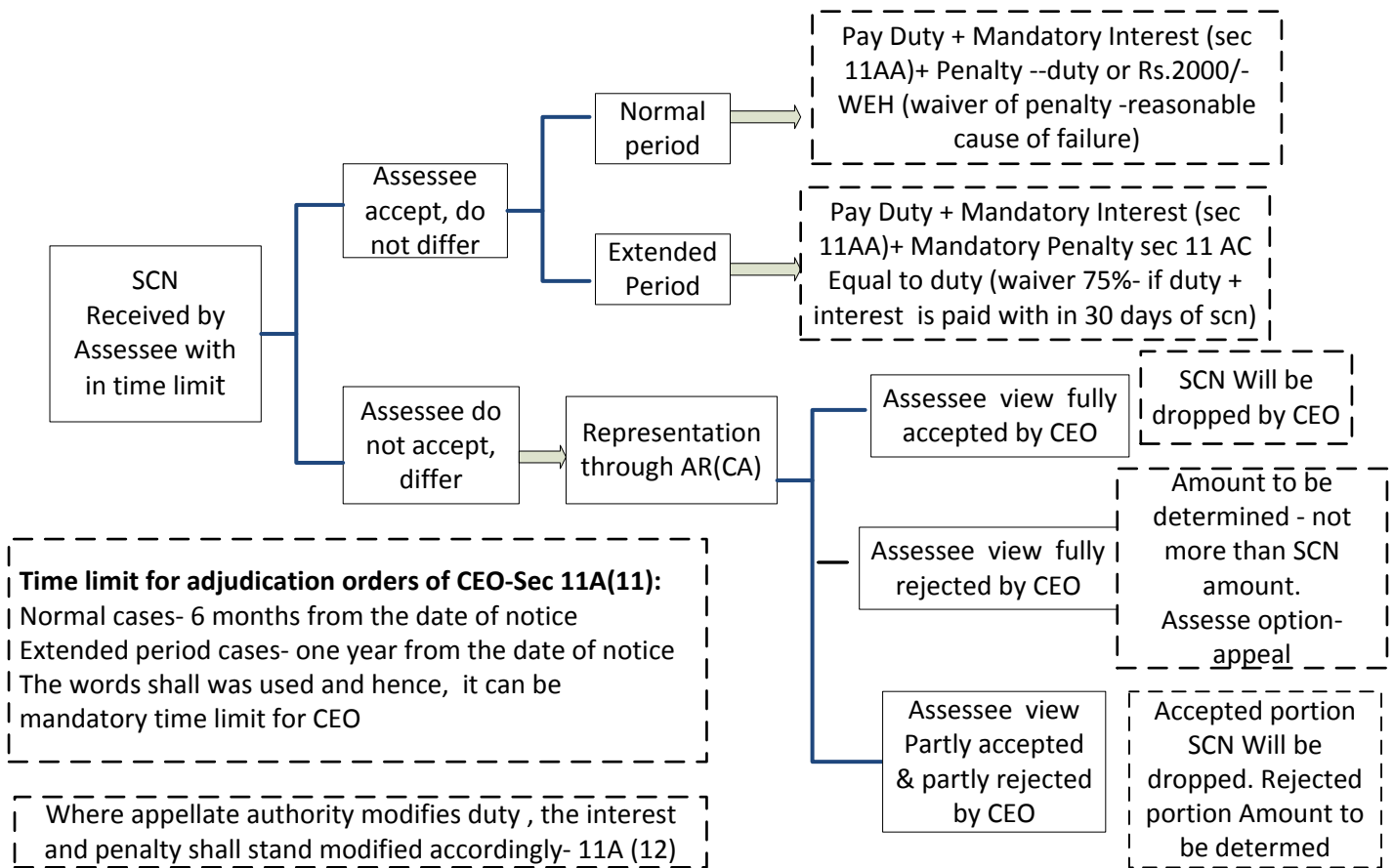

Mandatory Interest in case of Recovery of Duty- Sec 11 AA

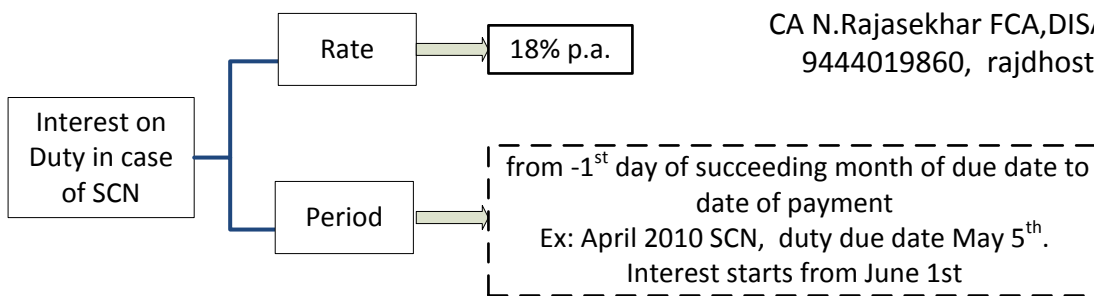

CA N.Rajasekhar FCA,DISA(ICAI) Chennai
 9444019860, rajdhost@yahoo.com

1. If SCN amount was increased in appeal, Interest on increased amount is payable from date of order- Sec 11 A (13)
2. Interest is payable whether the adjudication order shown interest separately or not- Sec 11 A (14)

For Other sections from 11 AC to 11 E, Point wise, self explanatory read the book

Excise Refund-Sec 11 B

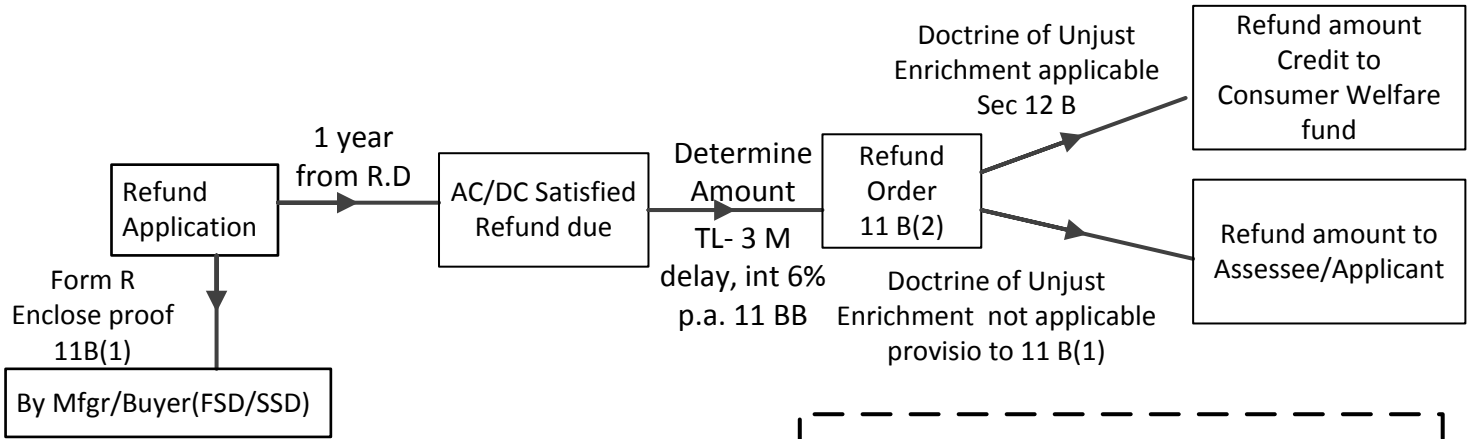

Relevant Date:

1 In case of Export Rebate

Export through aircraft/vessel-Date of leaving aircraft/Vessel Export through vehicle-Date of leaving custom frontier Export through post-Date of dispatch of article

2 In case of Compound levy scheme-Date of reduction of duty

3 In Case of Exemption u/s 5 A-Date of exemption order

4 In Case of Provisional Assessment-Date of final adjustment of duty

5-In case of FSD/SSD Date of Purchase of goods

6 In case of Order of court/Appellate authority-Date of order

7 In any other case Date of payment of duty

Doctrine of Unjust Enrichment/Refund credit to consumer welfare fund

- It is always assumed unless contrary proved by manufacturer that excise Duty burden normally fully passed on to buyer sec 12 B
- In such cases, refund of excess duty paid to the manufacturer will amount to excess and undeserved profit to him.
 - He will get double benefit – One from consumer and again from the Government.
 - At the same time, the duty is illegally collected and hence cannot be retained by Government, it will be credited to Consumer welfare fund
- The fund may be used for activities of protection and benefit of consumers. Provisions of Unjust enrichment will apply to all types of refund, (Provisional Assessment, Captive consumption Duty paid under protest etc)

CA N.Rajasekhar FCA,DISA(ICAI) Chennai 9444019860, rajdhost@yahoo.com

Non Applicability of Doctrine of Unjust enrichment (Refund paid to manufacturer / buyer)

- When duty is paid under protest and only lower amount of duty is charged to customer
- Pre-deposit of duty pending appeal
- When contract is for price inclusive of all duties
- When debit note is raised by buyer and amount deducted from bill
- When credit note issued to buyer and buyer account is credited,
- Refund of export rebate/incentive.
- Deposit taken from buyer against possible liability of excise duty. And deposit refunded

For Comparison with customs and service tax, read chapter 13 Division IV of the book

Indirect taxes Classes at Chennai and Bangalore

Chennai: Premier Academy Mylapore

044-24622694 / 9841661405

Bangalore: Shraddha academy

Rajaji Nagar, Bangalore

9141 888 592

23420603

Excise Administration

Hierarchy

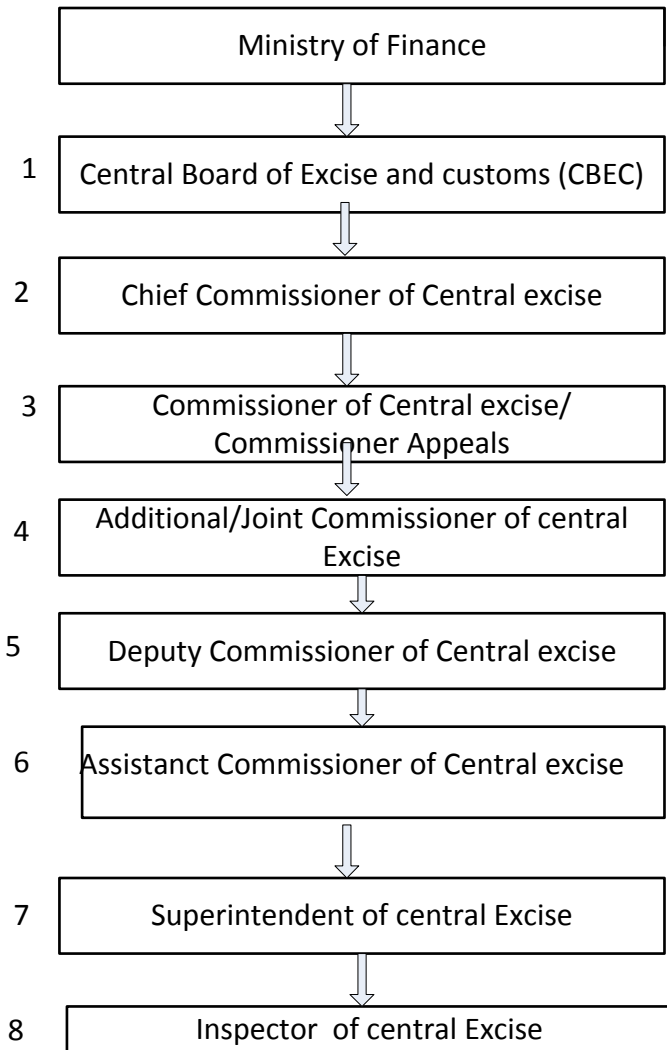

Sec 2(b) : C.E.O
 SI No. 2 to 6 & Officer CE Dept., Officer of State,
 Central Govt. powers entrusted by CBEC

Sec 2(a) : Adjudicating Authority:
 (Authority competent to pass orders under Act
 except Commissioner Appeals and CESTAT)

Segregation of functions/Division of work

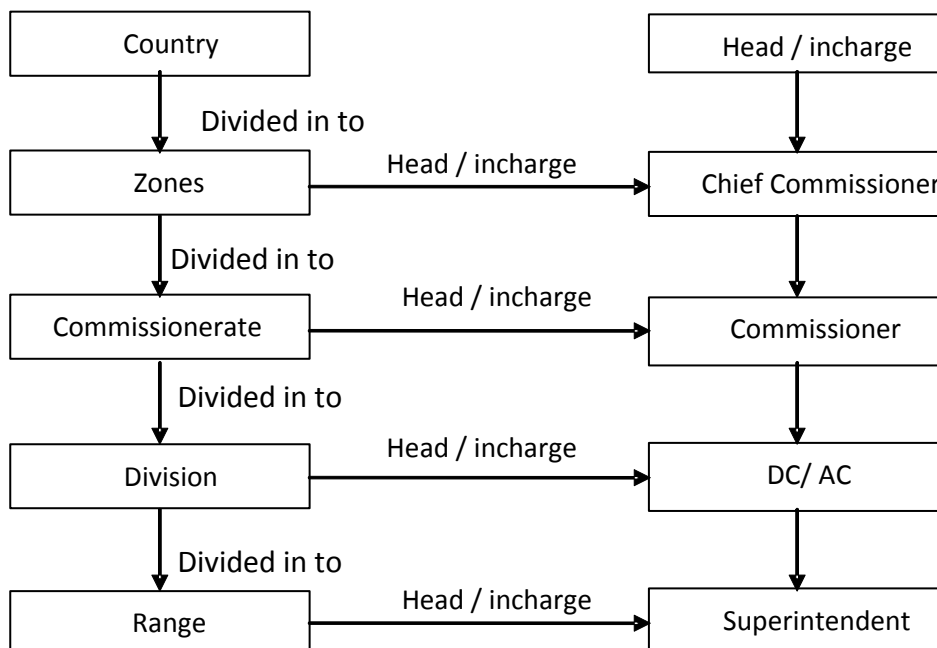

Excise Assessments

CE Rule 2(b), 'Assessment' includes self-assessment of duty made by the assessee and provisional assessment made under Rule 7

It normally implies determination of duty liability

Types of Assessments

- 1 Self Assessment Rule 6
- 2. Provisional Assessment Rule 7
- 3. Best Judgment Assessment

Self Assessment- Rule 6

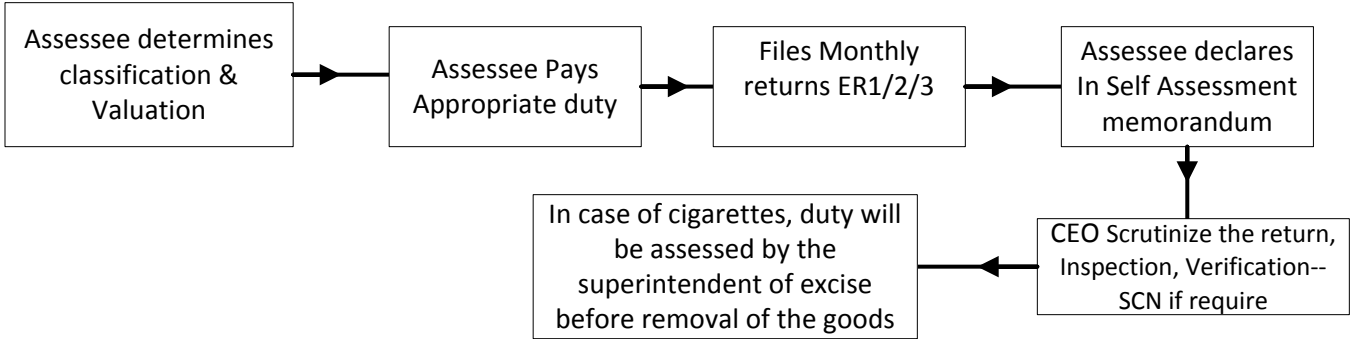

Provisional Assessment- Rule 7

CA N.Rajasekhar FCA,DISA(ICAI) Chennai
9444019860, rajdhost@yahoo.com

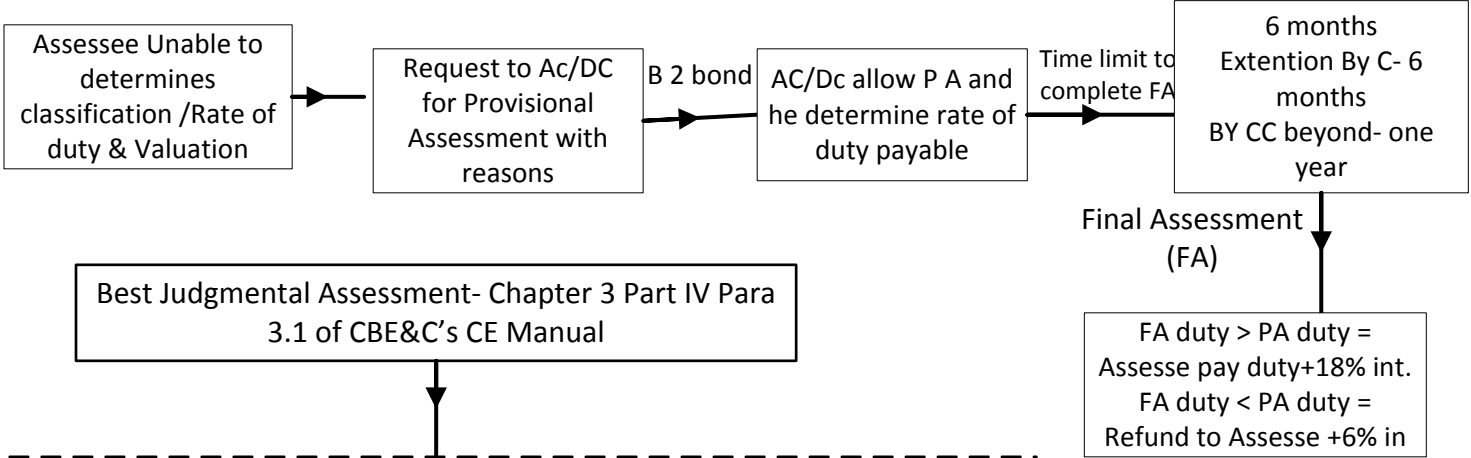

Best Judgmental Assessment- Chapter 3 Part IV Para 3.1 of CBE&C's CE Manual

- Best judgment assessment is made:**
- Where assessee fails to provide record /information for the purpose of assessment and Where the department is unable to issue demand.
 - Assessment done will be based on available information.
 - Demand will be issued if necessary.
 - Burden to provide information for re-determination of duty is on assessee.

For Comparison with customs and service tax, read chapter 13 Division IV of the book

Small scale Industries (SSI)- Notification No 8/2003 dt01.03.2003

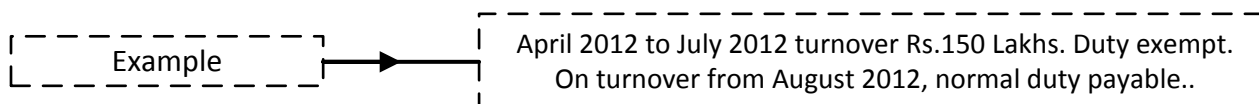
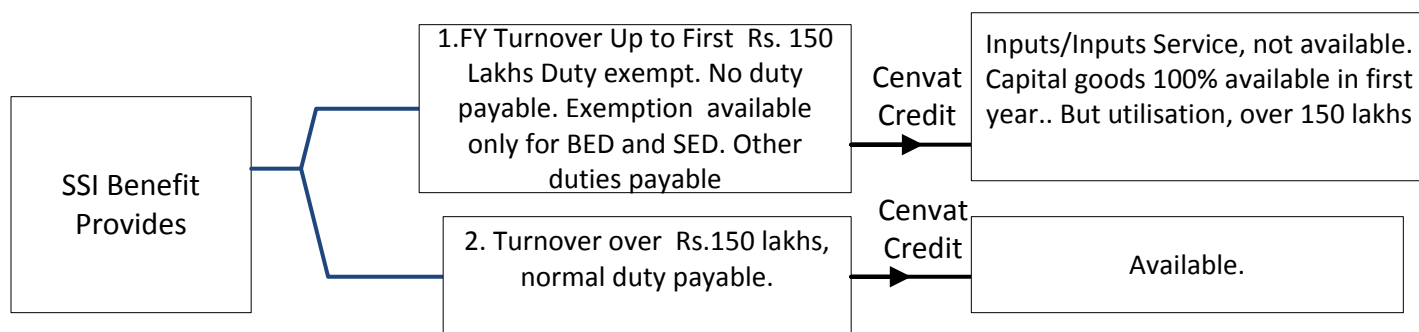
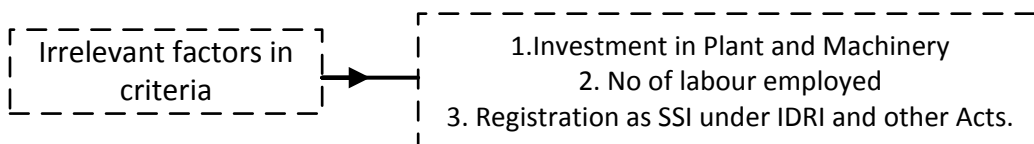
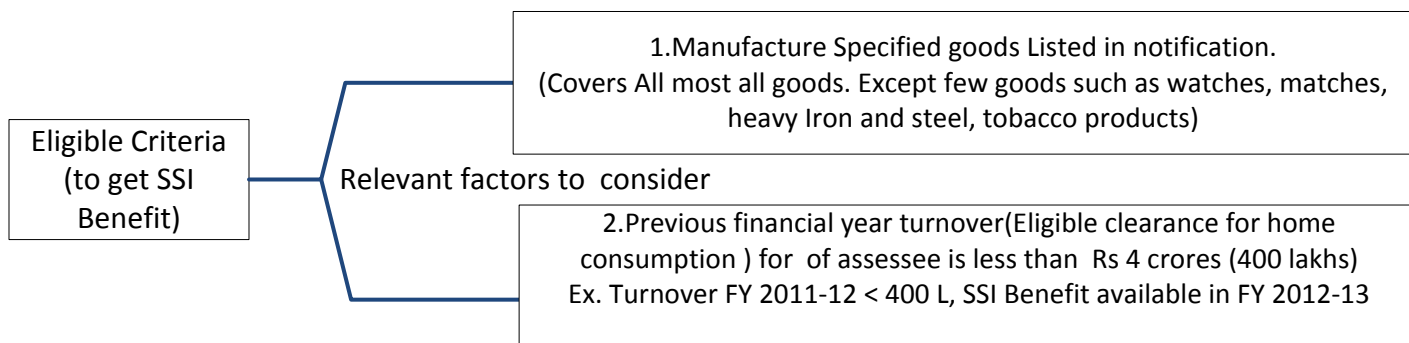

Procedural Concessions for SSI units

- No registration is required until they cross Rs.150 Lakhs of turnover.
- Quarterly return
- Payment of duty is to be done quarterly instead of monthly
- 100% CENVAT credit is available on capital goods in the first year.
- One Consolidated entry in PLA for all removals during the day.
- Audit should be done once every 2 to 5 years.
- Exemption for payment of duty if goods manufactured under brand name of others in rural area.

Obligation of SSI

- File a declaration with Superintendent when the turnover crosses 90 lakhs.
- Get a registration and maintenance of records when turnover crosses 150 lakhs.

CA N.Rajasekhar FCA,DISA(ICAI) Chennai
9444019860, rajdhost@yahoo.com

Small scale Industries (SSI)- Notification No 8/2003 dt01.03.2003

Clubbing provisions of SSI

When calculating the limits of 150 lakhs and 400 lakhs, the following factors will be clubbed:

- Turnover of the all products manufactured / all the factories or units of the assessee
- Turnover of factory used by more than one manufacturer in a financial year
- Turnover of clearance in the name of bogus /dummy/sham units
- Turnover of two units where there is substantial funding between two units
- Turnover of two units when change of ownership takes place during the previous year

However, the following will not be clubbed:

- Turnover of units of relatives/Turnover of same management units
- Turnover of the units having separate registration/ separate assessment/
Turnover of units having common partners/common directors

Calculation of turnover for limits (Value of clearances)

The calculation mode for Rs.150 and Rs.400 lakhs is same except few items.

Common Exclusions for 150 and 400 lakhs

CA N.Rajasekhar FCA,DISA(ICAI) Chennai
9444019860, rajdhost@yahoo.com

The following shall be excluded / not be considered from the turnover calculation for 150 lakhs and 400 lakhs

- Export turnover other than from exports to Nepal and Bhutan
- Clearance to SEZ/STP/EHTP/EOU/FTZ/EPZ/ **without payment of duty** /United Nations organization
- Export **under bond** through merchant exporter
- Turnover of goods manufactured with other's brand name in urban area (No SSI benefit, duty payable)
- Turnover of inputs/capital goods bought by assessee and cleared as such (since it is not a manufacture)
- Job work turnover exempt under notification 214/86,83/94 and 84/94
- Goods may be exempt under some other notification, i.e. other than SSI exemption notification - Final product of such goods
- Value of intermediate products used as inputs in manufacturing final products which are eligible for SSI exemption
- Job work of test, repairs, reconditioning, processing, etc. which is not a manufacture.
-

Common Inclusions for 150 and 400 lakhs

The following shall be taken in to account while calculating the turnover (value of clearances for both 150 lakhs and 400 lakhs):

- Exports to Nepal and Bhutan (To be included even money received in foreign currency){
- Goods manufactured with other's brand name in rural area (SSI need not pay duty on these goods, But include for limits)
- Clearances which are eligible for SSI benefit where no duty payable (goods manufactured in the brand name of Khadi village, National small scale industries, Turnover of Packing material, notebooks, writing pads)
- Goods may be exempt under some other notification, i.e. other than SSI exemption notification - Intermediate product of such goods
- Turnover of goods charged to Nil duty

Turnover of Non excisable goods

Differential treatment

The following is to be included in 400 lakhs limits calculation and to be excluded for 150 lakhs limits calculation

- Turnover of goods which are exempt from duty other than SSI Notification and Other than Job work notification (For example U/s 5A notification)

Appeals under Central Excise

Appeals to Commissioner appeals sec 35 & 35 A

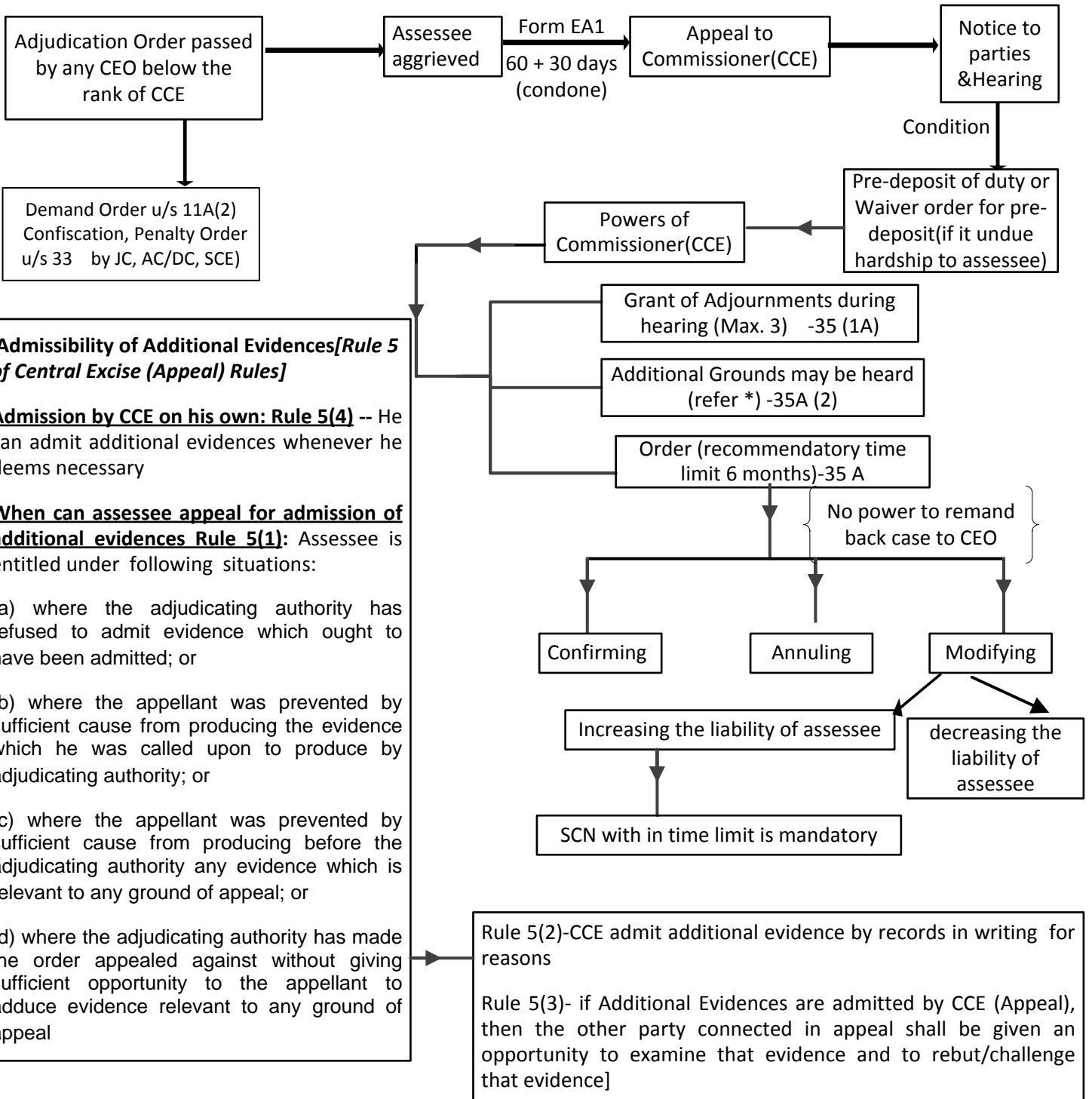

CA N.Rajasekhar FCA,DISA(ICAI) Chennai 9444019860, rajdhost@yahoo.com

For Comparison with customs and service tax, read chapter15 Division IV of the book

Appeals under Central Excise- 2

Appeals to Tribunal sec 35B,35 C & 35 D

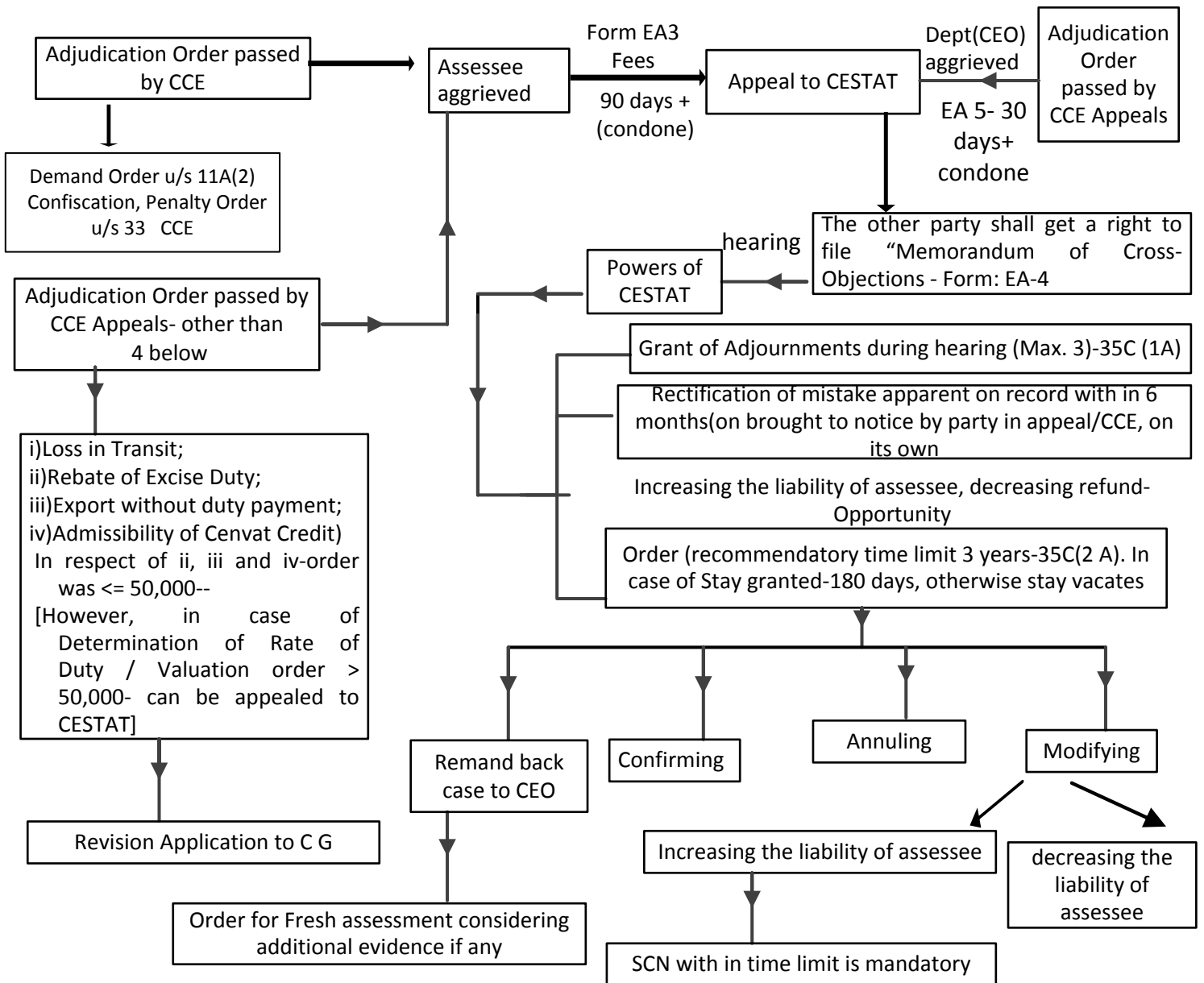

Other inherent Powers of CESTAT:

1. Recall dismissed order, if deposit of duty as ordered paid late
 2. Quash its own order, if found obtained by fraud, disregard of statutory provision, by mistake
 3. Correct an error so that justice is done
- The above powers are subject to some limitations.

Tribunal has no powers to review its orders on its own.

CA N.Rajasekhar FCA,DISA(ICAI) Chennai
9444019860, rajdhost@yahoo.com

For Comparison with customs and service tax, read chapter15 Division IV of the book

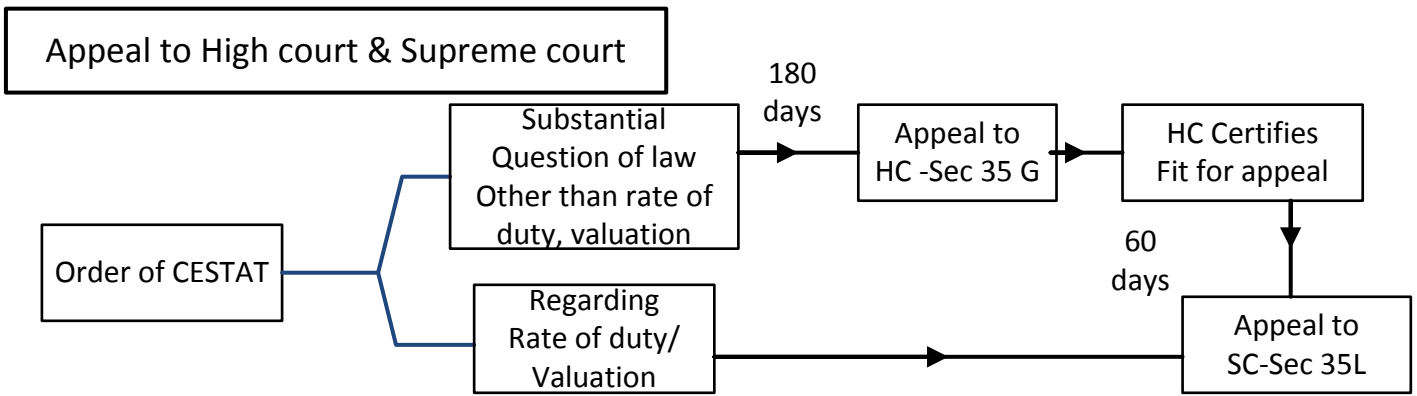

Revision Application to Central Government- Sec 35 EE

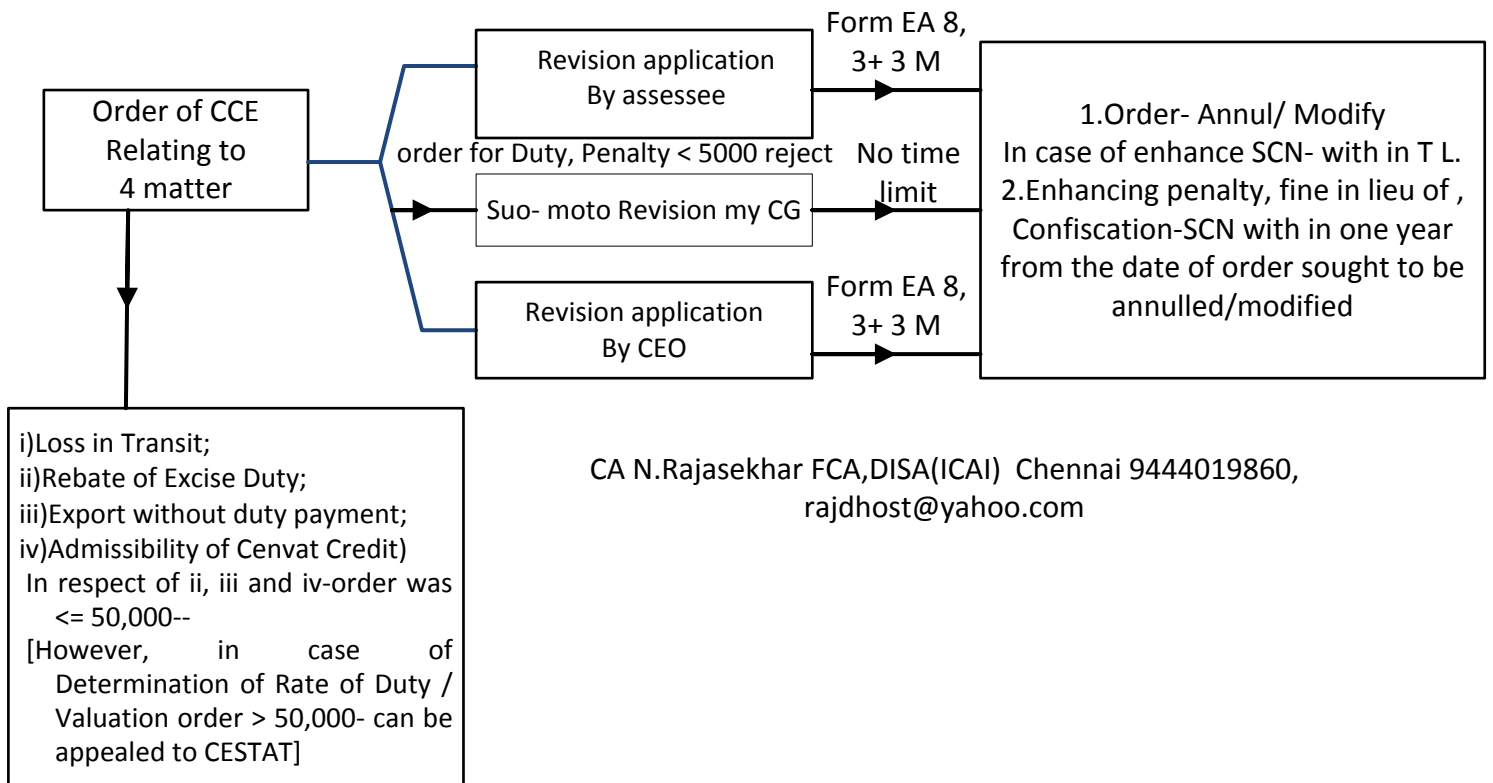

For Comparison with customs and service tax, read chapter 15 Division IV of the book

Indirect taxes Classes at Chennai and Bangalore

Chennai: Premier Academy Mylapore
044-24622694 / 9841661405

Bangalore: Shradha academy
Rajaji Nagar, Bangalore
9141 888 592
23420603

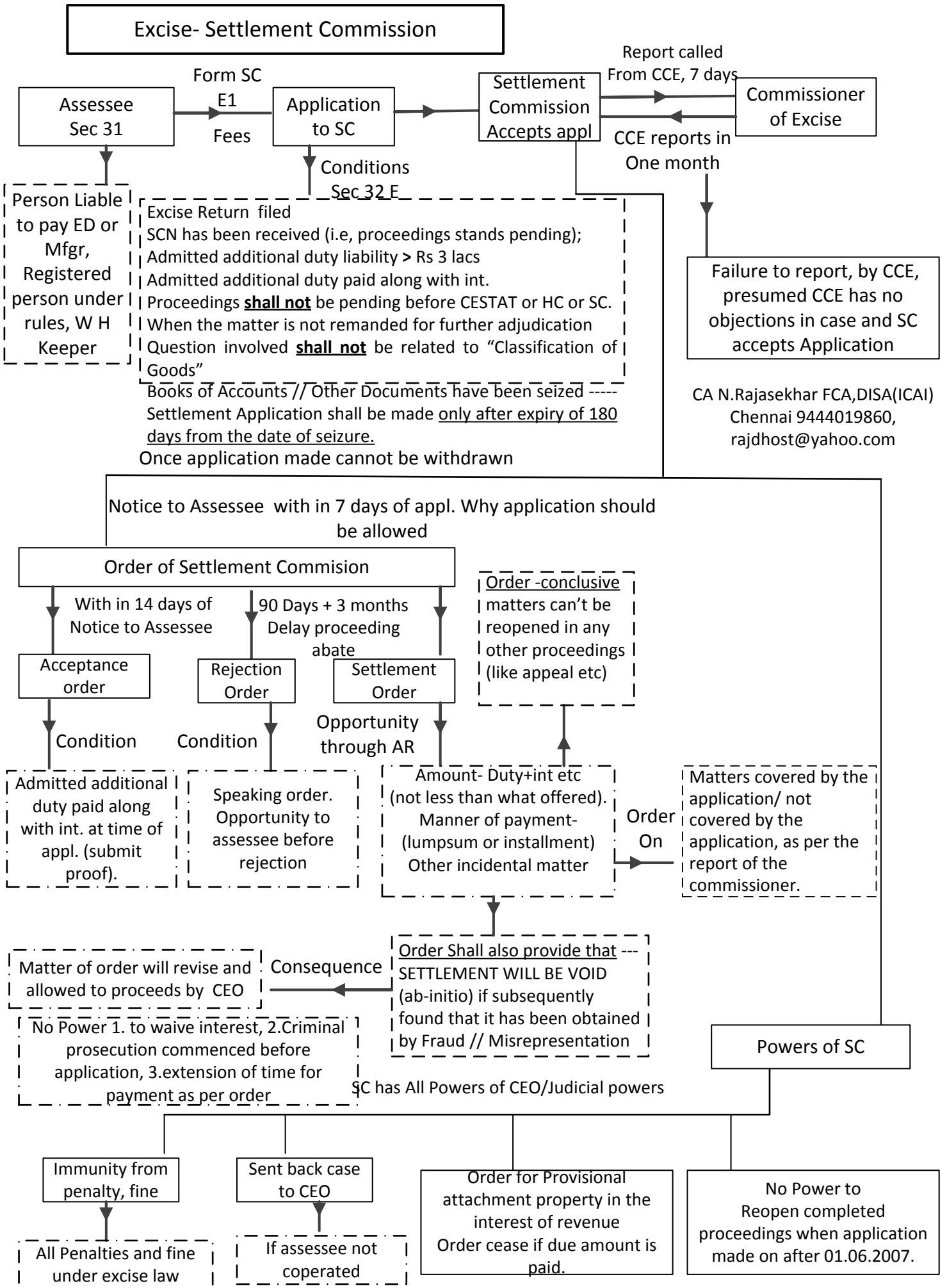

For Comparison with customs and service tax, read chapter16 Division IV of the book

Excise- Authority for Advance Ruling- Sec 23 A to 23 H

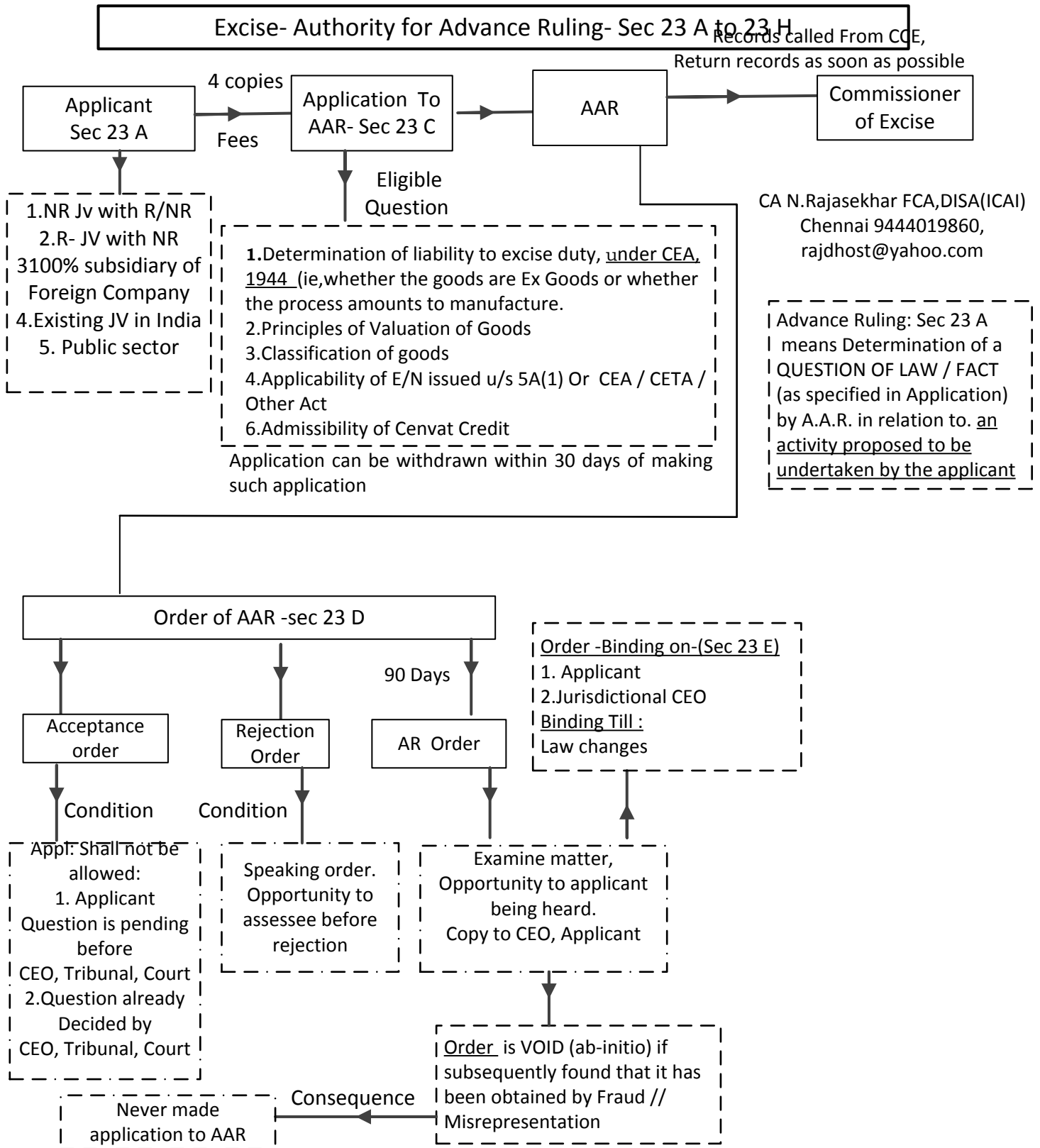

Benefit of seeking advance ruling from Authority would be applicable only in relation to activity which is proposed to be undertaken (& not in respect of that which has already been undertaken) --- MCDONALD'S INDIA PVT. LTD.-

Merely because another subsidiary is carrying out the same activity and its case is pending with the CEO, another subsidiary will not become ineligible to obtain AR in relation to same question".

A.TEX (INDIA) PVT. LTD. – SC-

For Comparison with customs and service tax, read chapter16 Division IV of the book

Excise- Civil Penalties

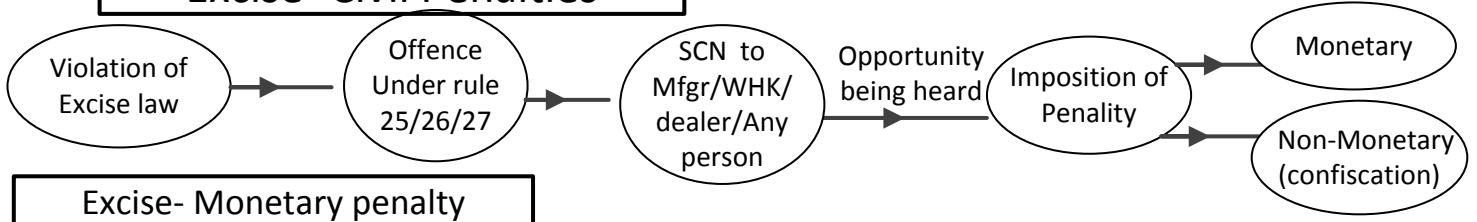

Excise- Monetary penalty

<p>Offences Under Rule 25 Removing excisable goods in contravention of excise rules or notifications issued under the rules;</p> <ul style="list-style-type: none"> •Not accounting for excisable goods manufactured, produced or stored; •Engaging in manufacture, production or storage of excisable goods without applying for registration certificate under section 6 of the CE Act; •Contravening any provision of Central Excise Rules or notifications issued under these rules with intention to evade payment of duty. 	Penalty can be levied on	Mfgr/WHK/dealer Max Rs.2000/ or duty on goods which ever is higher & Confiscation
<p>Offences Under Rule 26(1) Any person who knows or has reason to believe that excisable goods are liable to confiscation</p> <ul style="list-style-type: none"> ➤ Acquires possession of such excisable goods or ➤ Transports removes, deposits, keeps, conceals, sells or purchases such excisable goods or ➤ In any other manner, deals with any such excisable goods 	Penalty can be levied on	Any person Max Rs.2000/ or duty on goods which ever is higher
<p>Offences Under Rule 26(2): Does not issue invoice/issues excise invoice without delivery of goods specified therein/Issues any documents whereon receiver takes any ineligible benefit of CENVAT or refund</p>	Penalty can be levied on	Any person Max Rs.5000/ or Value of benefit which ever is higher
<p>Offences Under Rule 27: General penalty: For breach of excise rules, if no penalty has been prescribed under Act or rules</p>	Penalty can be levied on	Any person Max Rs.5000/ And Confiscation Also possible

Excise- Non Monetary penalty- Confiscation

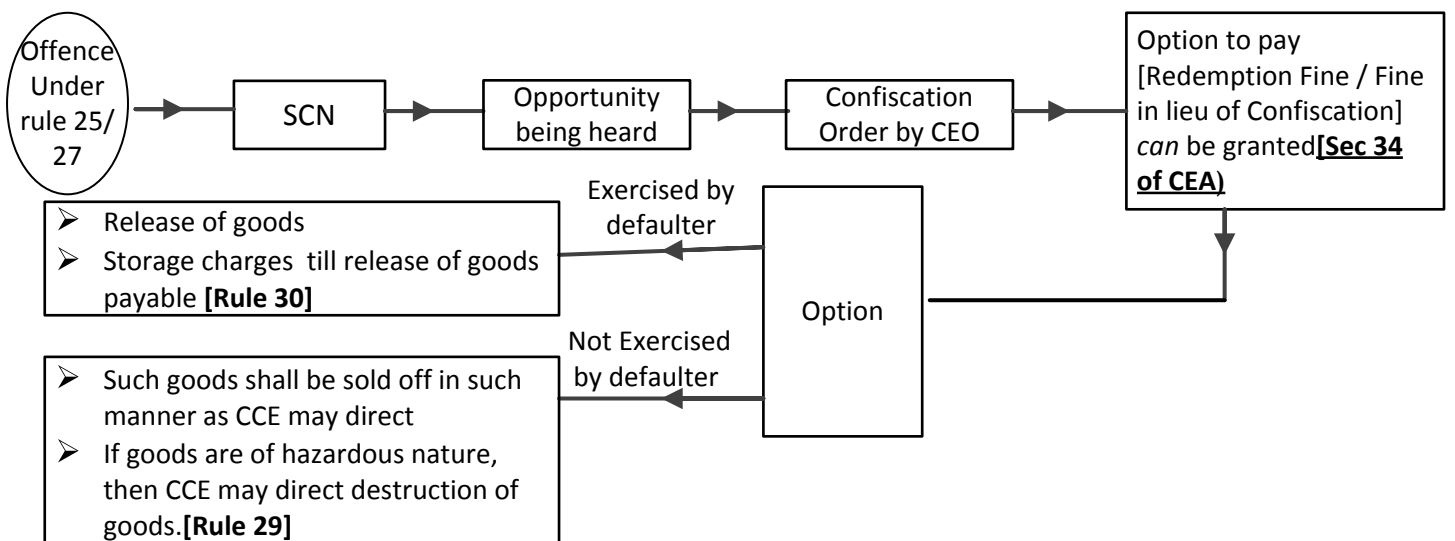

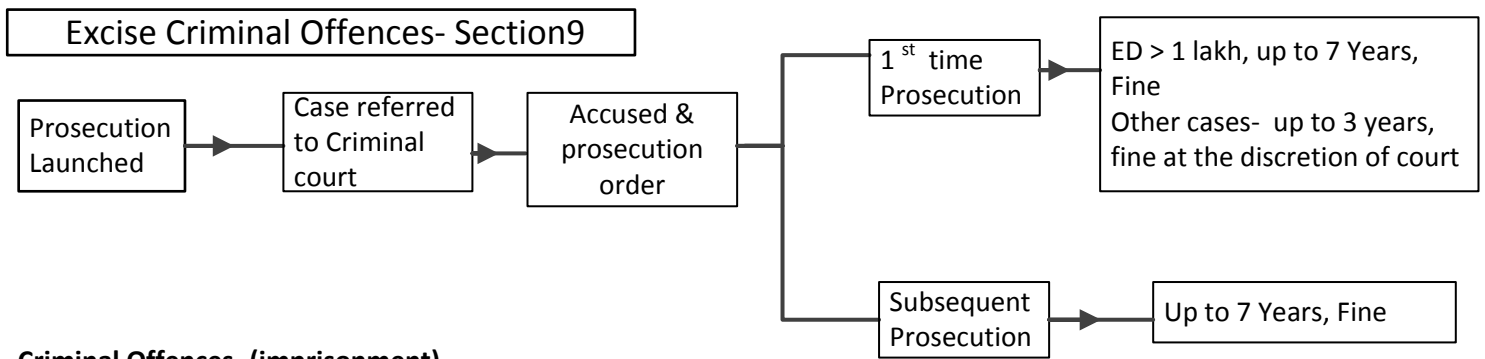

Criminal Offences- (imprisonment)

- 1) Possession of "Tobacco" in excess of prescribed quantity;
- 2) Evading payment of excise duty;
- 3) Removal any excisable goods in contravention of any provisions of CEA / Rules or *in anyway concern himself with such removal*;
- 4) -- Acquiring possession of, or
 - In anyway concerning himself in Transporting/ Depositing/ Keeping/Concealing, selling or purchasing, or
 - In any other manner dealing with goods which he knows or has reason to believe are liable to confiscation;
- 5) Contravention of any provisions of Cenvat Credit Rules, 2004;
- 6) Failure to supply the information which he is required to supply under the act or supplying false information;
- 7) Attempting to commit or abetting the commission of, first two categories of offences.

Term of 7 years imprisonment can be reduced to a minimum of 6 Months if the Court, shall be satisfied that there exists "SPECIAL & ADEQUATE REASONS".

Reasons not admissible as "Special & Adequate Reasons:

- i) Conviction for the first time
- ii) Penalty has already been imposed/ Goods have been confiscated/ Other action has been taken
- iii) Age of the accused
- iv) Accused merely secondary party, not the principal offender

CA N.Rajasekhar FCA,DISA(ICAI) Chennai
9444019860, rajdhost@yahoo.com

Sec 9A

Offence to be non-cognizable: No arrest in respect of these Offences shall be made without obtaining arrest warrant.

Offence can be Compounded: For that request to be made to Chief CCE (such request can be made before launch of prosecution proceeding and even after launch of prosecution proceeding) --- Any of the offence is compoundable on payment of prescribed fee.

Customs Duty liability Sec 12

Sec 12 of customs provides customs duty shall be levied at such rates specified in Customs Tariff Act, 1975, or any other law for the time being in force, on goods imported into and exported from India. Duty payable on goods imported by government also.

India includes territorial waters of India. Consequently, even an innocent entry of a vessel into the territorial waters of India would result in import of goods. It was impossible to determine when exactly the vessel crossed the territorial waters limit Hence taxable event was settled as below

Taxable event for Import goods

Example- Goods imported from USA Port to Chennai port

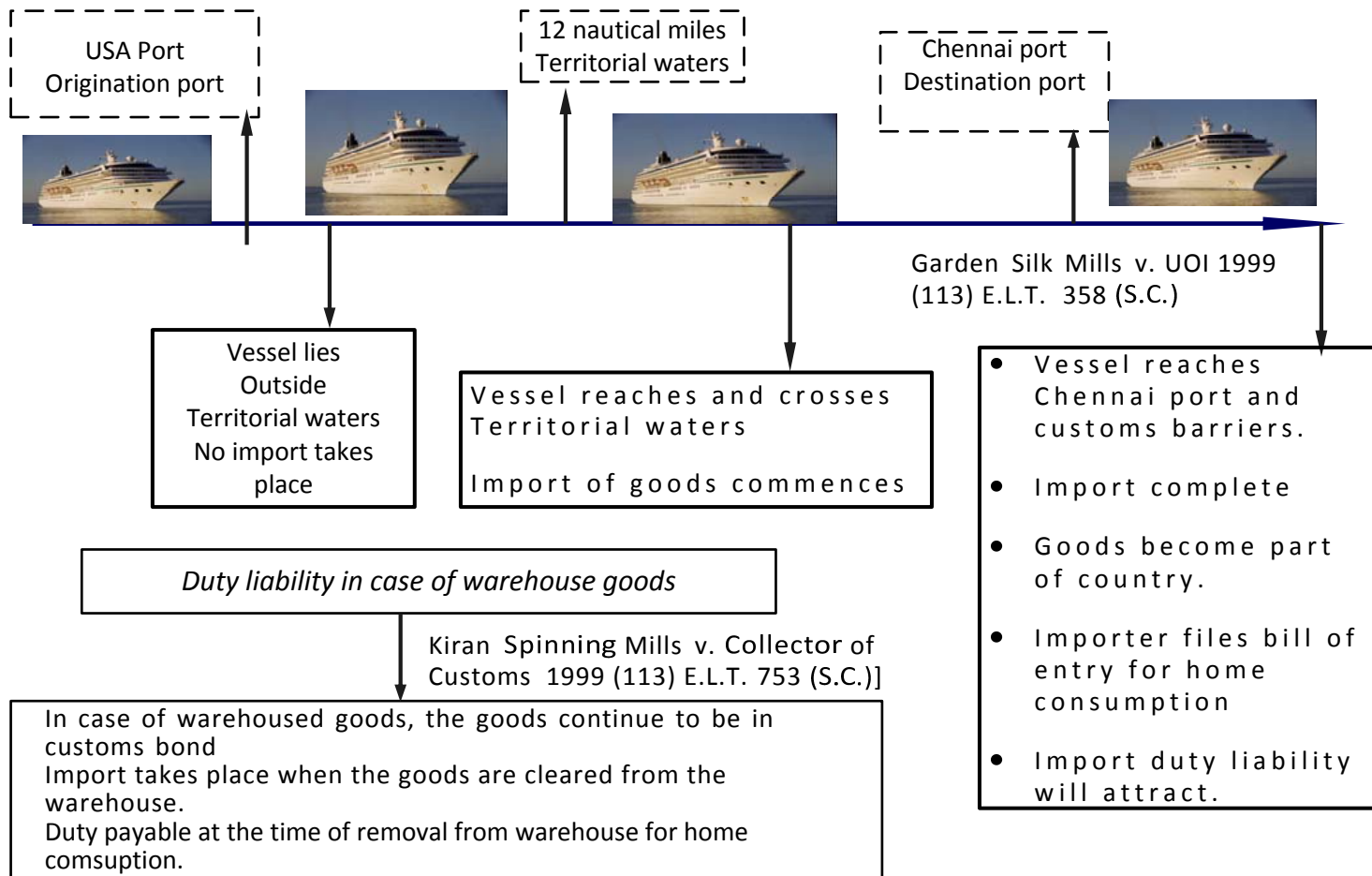

CA N.Rajasekhar FCA,DISA(ICAI) Chennai 9444019860, rajdhost@yahoo.com

Taxable event for Export goods

Example- Goods Exported from Chennai Port to USA port

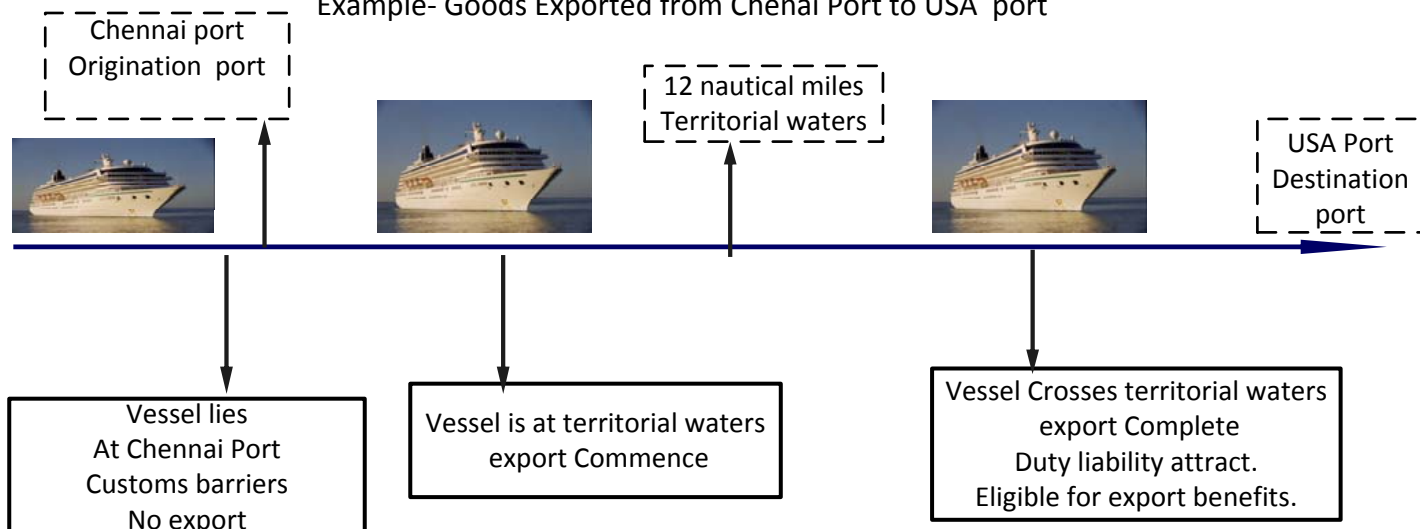

CA N.Rajasekhar FCA,DISA(ICAI) Chennai 9444019860, rajdhost@yahoo.com

Customs Valuation 1-



Tariff value is over riding of transaction value. If tariff values fixed, value should be as per tariff value

“Transaction value” Valuation Imported goods

Transaction value of imported goods read with Valuation rules

Cost and services to add Rule 10(1)

- (a)(i)** Commission & Brokerage Paid in India

(ii) Cost of Containers;

(iii) Cost of Packing (*Labour or Material*).

(b)Value of Assists [4 Types] Place of origin India or Outside India

i)Materials / Components / Parts contained in FP

ii)Tools/ Moulds / Dies / Similar Items :

iii)Materials consumed in production of imported goods:

iv)Eng. / Development/Art Work/ Design Work / Plans & Sketches (*Place of Origin: Must be Outside India*):

(c)Royalties & License Fees in connection with sale except “*Charges for Right of Reproduction of Imported Goods in India*”

(d)Subsequent Sale Proceeds – accruing to the seller [But “*Dividend Payments*” – Not Includible (since payment of dividend can’t be equated with accrual of sale proceeds subsequently)]

(e)All Other Payments made by buyer

--- Payment is made as a condition for sale of imported goods; &

--- Payment is made by buyer to the seller directly or to a third party to satisfy an obligation of seller

Rule 10: Transaction value = Price of goods sold at the time and place of importation + costs and services, assists (i.e CIF Value All costs up to destination port)

Rule 3:TV will be accepted only

- 1.No restrictions on use of goods (except law, geographical use restrictions) Restrictions which do not affect value of goods.
2. Price is not subject to condition where price cannot determine.
3. Buyer and seller not related to each other

TV in case of relative is accepted if (i) relationship does not influence price (ii) Importer demonstrates Price is close approximation to identical/similar goods /deductive value/computed value

Rule 12:When proper officer has doubt about truth and accuracy of TV, he can ask information, still doubt can reject TV by giving opportunity

Cost and services to add Rule 10(2)

- (a)**Cost of Transport;
Actual amount. If not ascertainable 20% of FOB
In case of Air, Actual restricted to 20% of FOB

(b)Transit Insurance;
Actual amount, if Not ascertainable 1.125% of FOB

(c)Landing Charges- flat 1% of CIF

(d) demurrage charges

Cost and services to exclude not to add(post importation costs)

- (a).Charges for Construction, Erection, Assembly, Maintenance or Technical assistance, Undertaken after importation

(b)The cost of transport after importation

(c)Duties and taxes in India

(d)Interest on Delayed Payments

Customs Valuation 2

If transaction value is not determinable under rule 3, the value shall be determined as per following rules in order

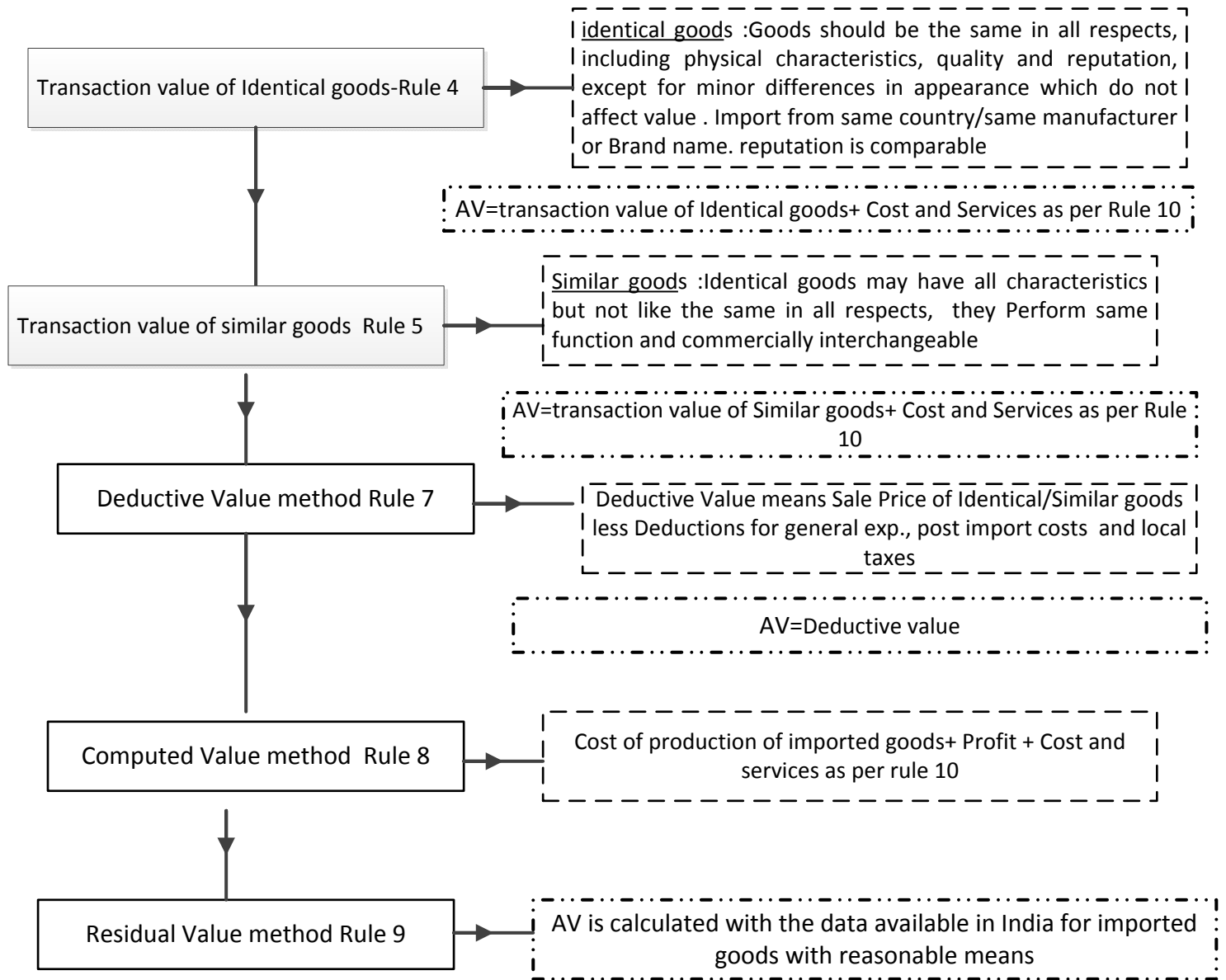

CA N.Rajasekhar FCA,DISA(ICAI) Chennai
9444019860, rajdhost@yahoo.com

Meaning of relative Rule 2 (2)

1. They are

- Officer/Director in each other's business
- Legally Recognized partner
- Employer & Employee;
- Members of same family;

2. Both of them

- Are controlled by a third person;
 - Control a third person;
- ONE OF THEM**
- Control the other

3. Any person

- Owns/controls 5% or more of voting power/ shares in both of them;
-

Explanation:

- 1. Person include legal person
- 2. Sole Distributor/ Sole Selling Agent – shall not be treated as RP unless they fall under any of the above criteria

Customs Valuation 3

“Transaction value” Valuation Export goods

Transaction value of Export goods

: Transaction value =Price of goods sold at the time and place of Exportation (i.e FOB Value) All costs up to origination port

T V in case of relative is accepted if (i) relation ship does not influence price

Rule 8:When proper officer has doubt about truth and accuracy of TV, he can ask information, still doubt can reject TV by giving opportunity

CA N.Rajasekhar FCA,DISA(ICAI) Chennai
9444019860, rajdhost@yahoo.com

If transaction value is not determinable under rule 3, the value shall be determined as per following rules in order

Transaction value of goods of kind and Quality -(Determination of Export Value by Comparison-Rule 4

Goods of kind and Quality -similar to that Identical goods/ similar goods

AV=transaction value of goods of kind and Quality-

Computed Value method Rule 5

AV= Cost of production of export goods+ Design charges+ Profit

Residual Value method Rule 9

AV is calculated with the data available in India for export goods with reasonable means

Import procedure through Air and water an overview

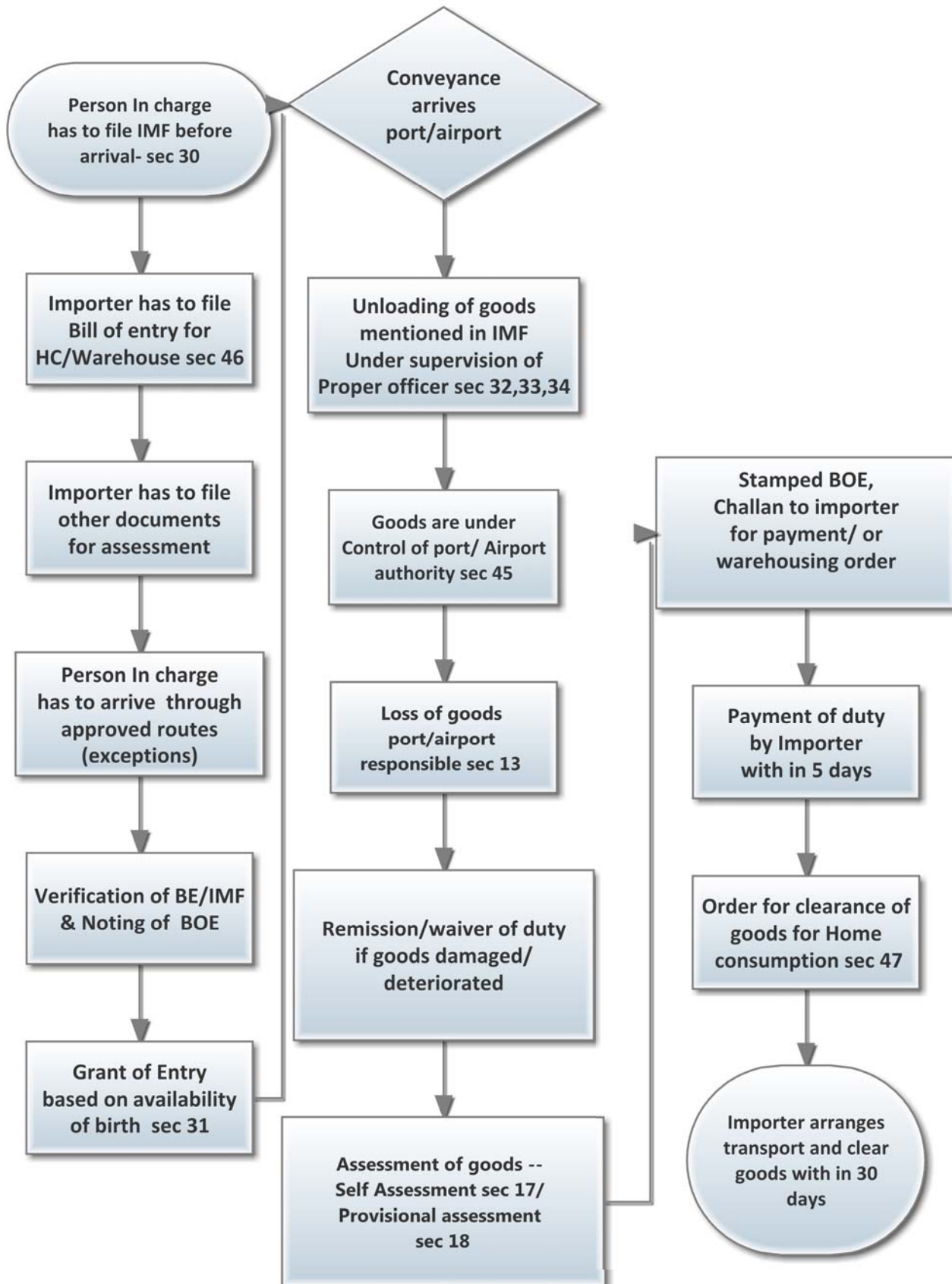

Export procedure through Air and water an overview

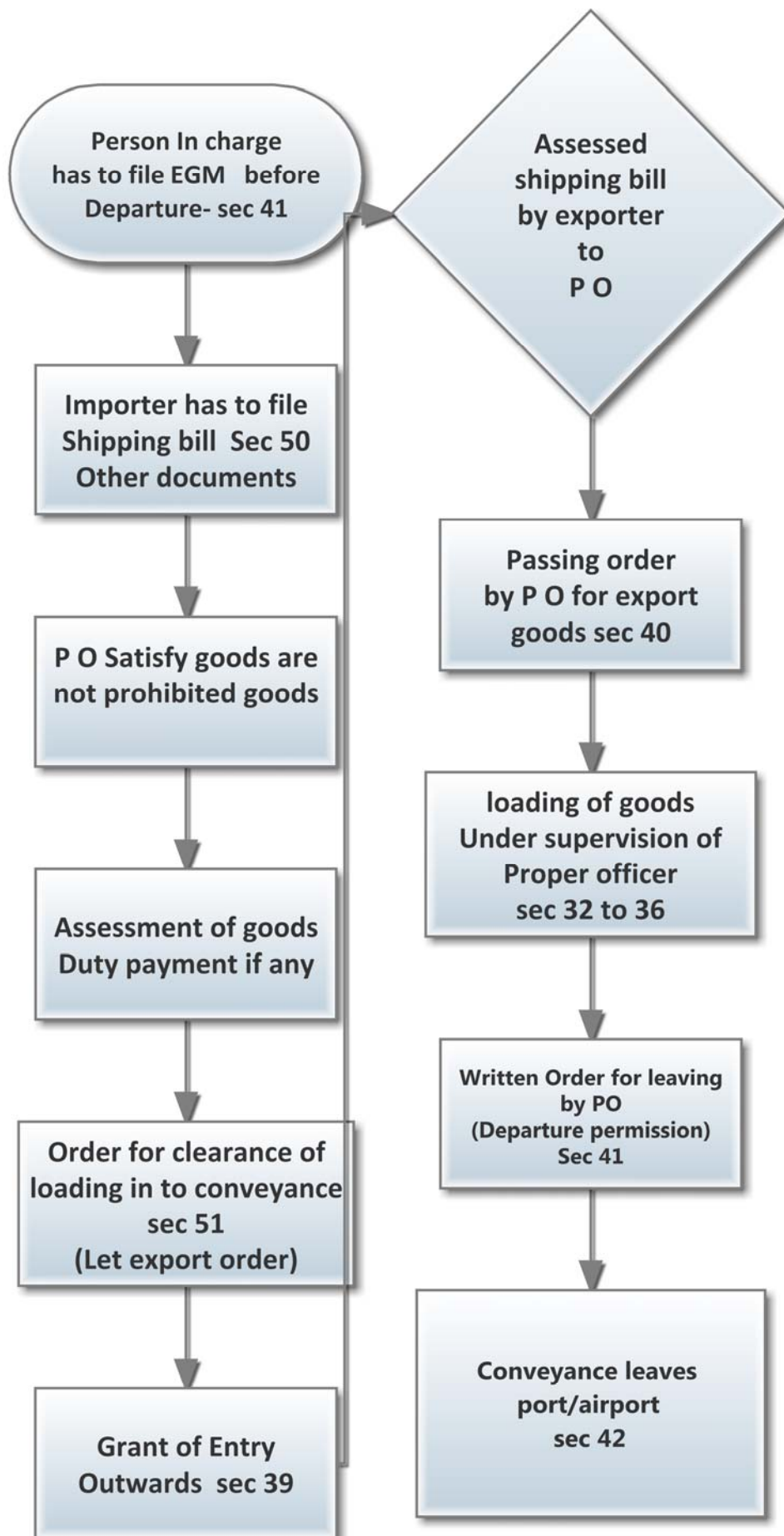

Relevant date for Imported Goods

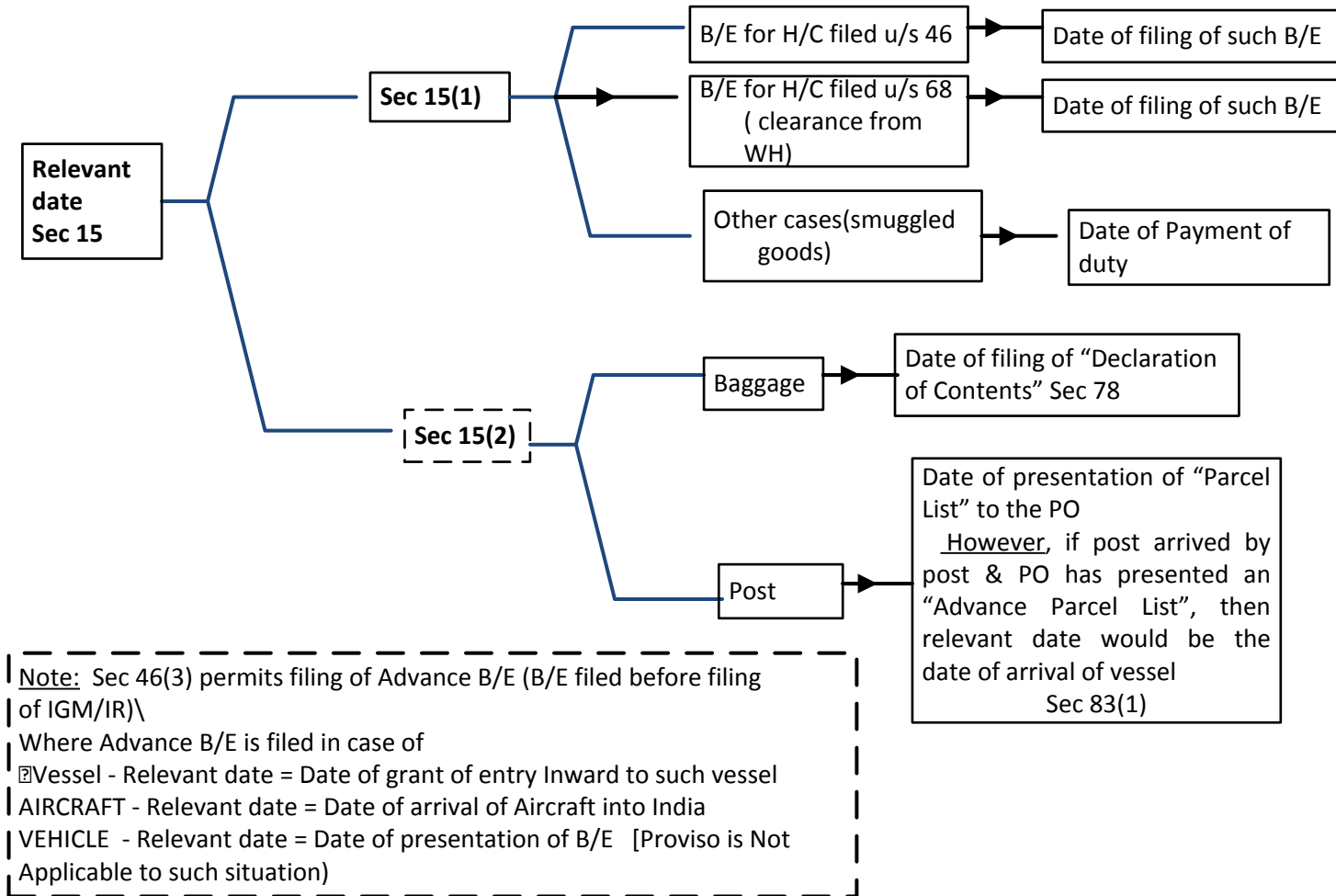

Relevant date for Export Goods

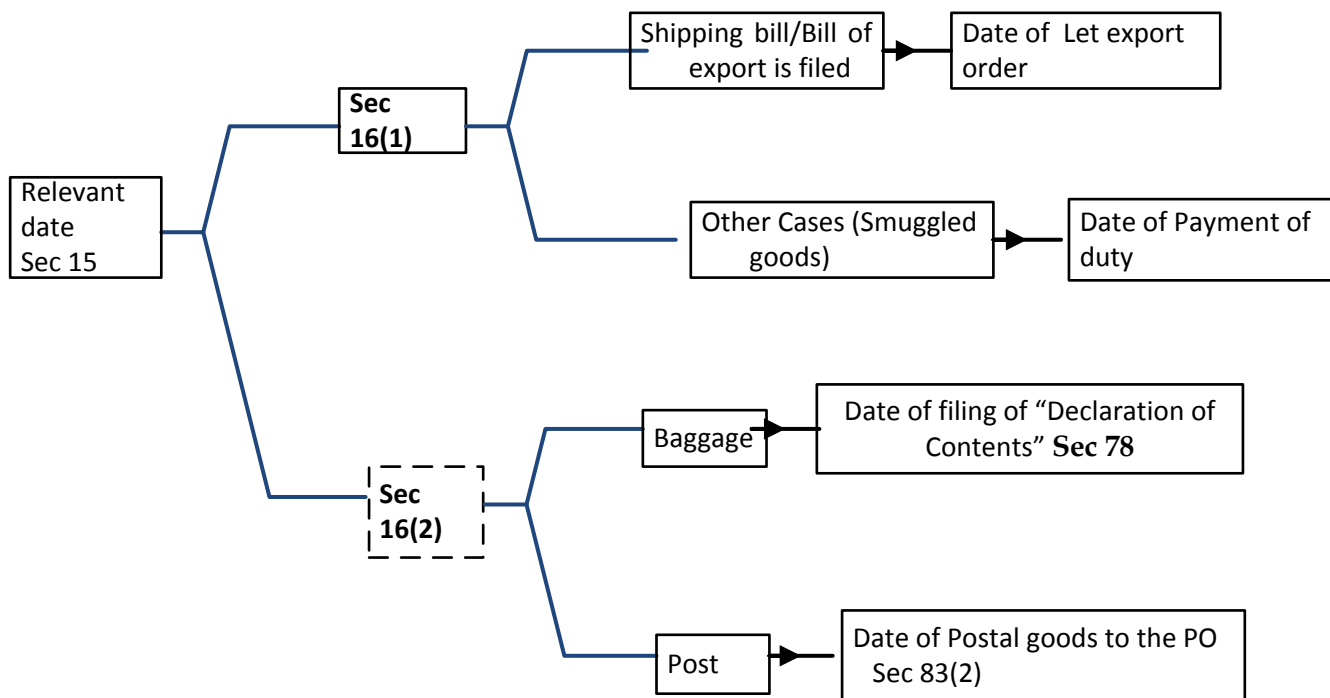

WAREHOUSING OF IMPORTED GOODS

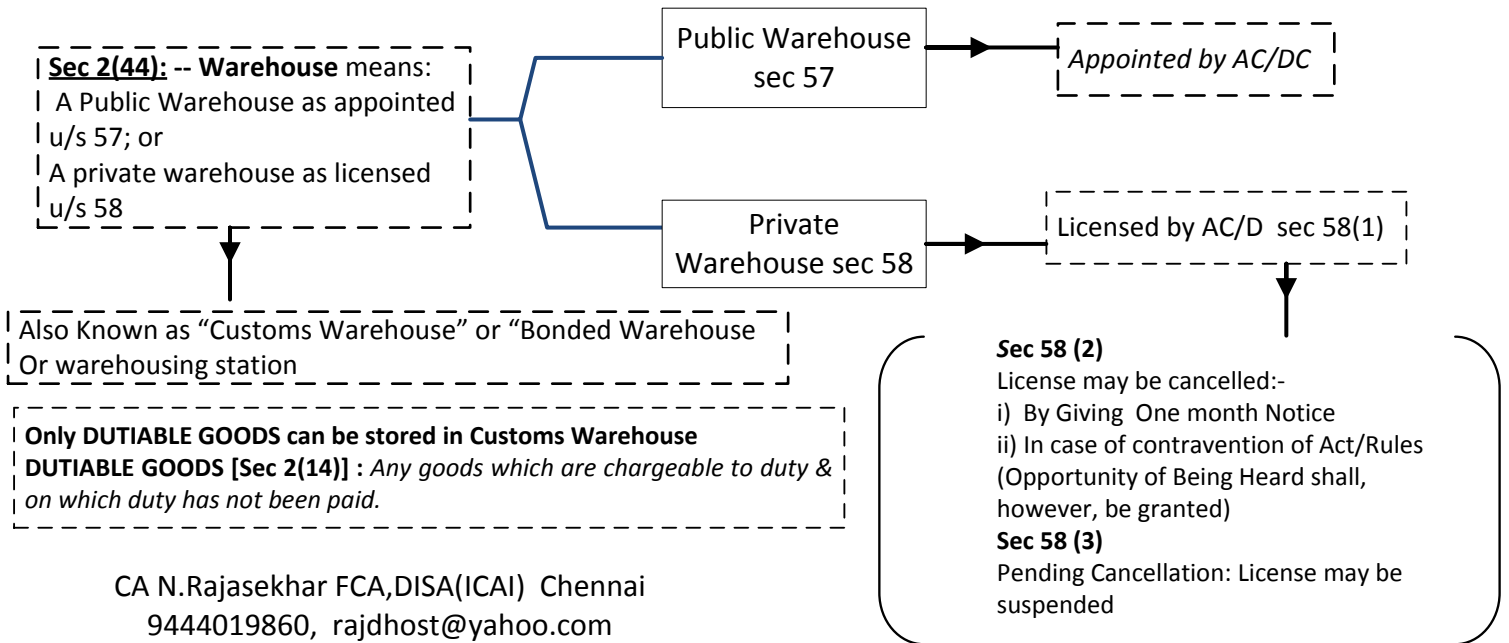

WAREHOUSING Procedure

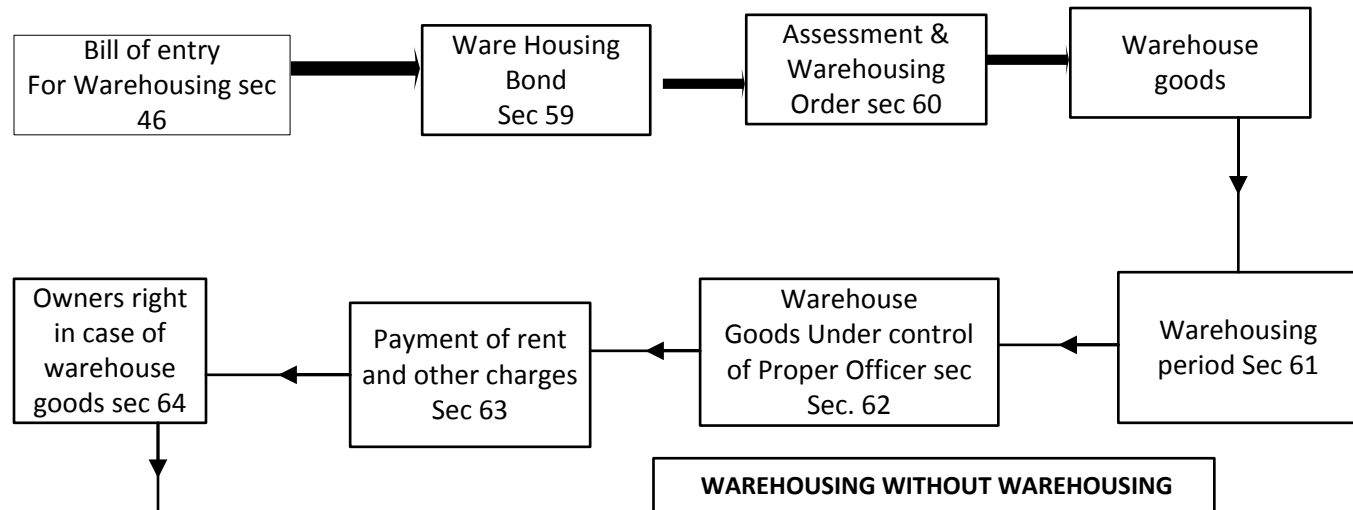

If the goods reached the warehouse, without following ALL or ANY of the following conditions, then it is called WAREHOUSING WITHOUT WAREHOUSING

(i) **Proviso to Sec 46(1):** Inability of importer to file any B/E (whether for H/C or for W/Hing) – due to non-availability of full information --- Goods may be allowed to be deposited in PUBLIC Warehouse

ii) **Sec 49:** B/E for H/C filed by importer –inability to clear the goods within a reasonable time – Goods may be allowed to be deposited in Warehouse (Public W/H or Private W/H) (Such goods may be dutiable or non-dutiable)

iii) **Sec 85:** B/E filed for Warehousing – Importer submitting a declaration that these are to be supplied as Stores – without payment of duty (i.e., to Foreign Going Vessel/Aircraft or Ship of Indian Navy) --- such stores may be warehoused without assessment of duty thereon (i.e., No Bond Execution).

WAREHOUSING OF IMPORTED GOODS-2

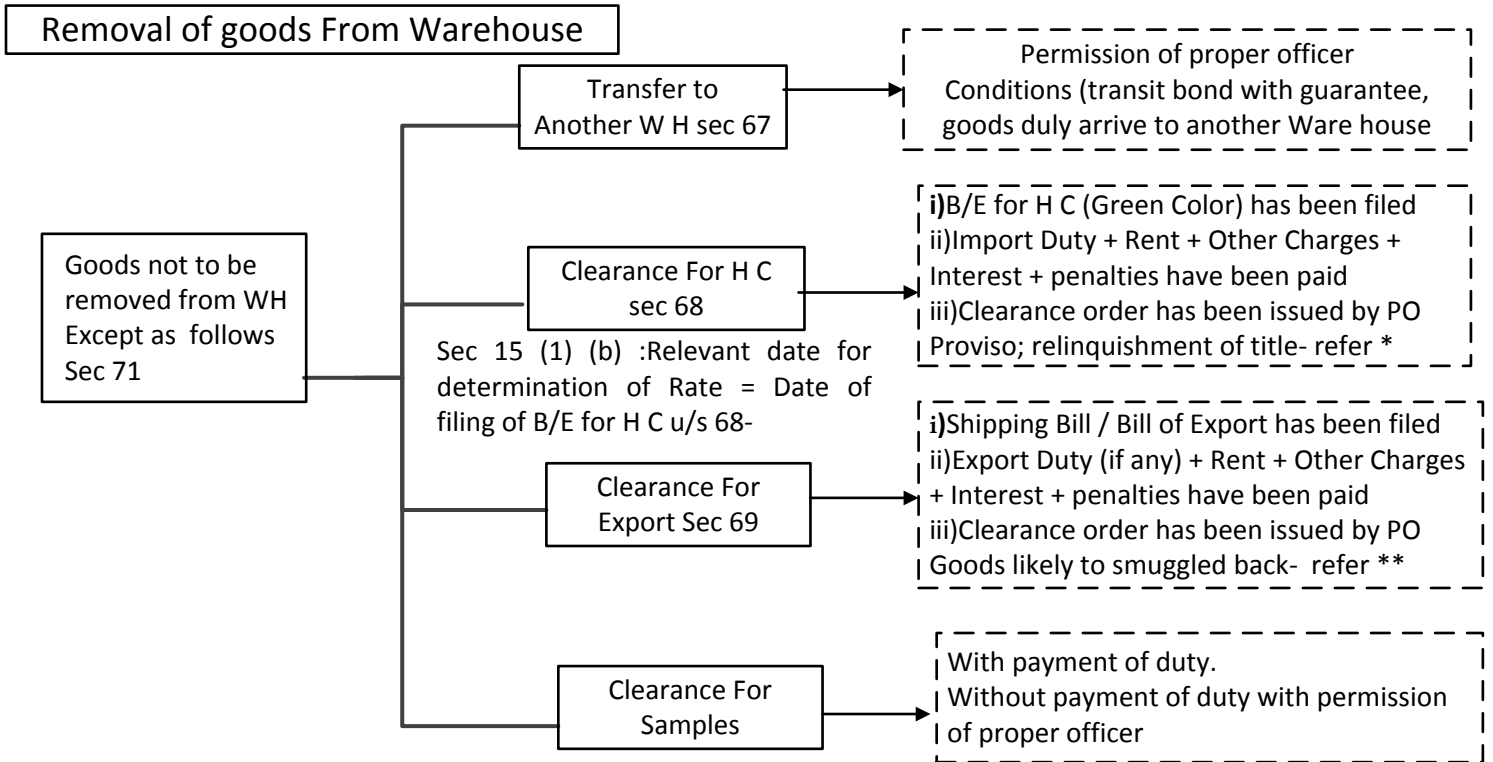

*** Relinquishment of title by owner of warehouse goods Proviso: to sec 68**
*Importer may relinquish his title to goods **Before passing of Clearance Order** for Home consumption-*
Then, he shall not be liable to pay DUTY.. Title may be relinquished only upon payment of ware housing dues such as Rent, interest, penalty and other charges,)
 In respect of any goods where **offence has been committed** under customs Act or any other law, **relinquishment cannot be made.**

CA N.Rajasekhar FCA,DISA(ICAI) Chennai 9444019860, rajdhost@yahoo.com

**** Goods likely to be smuggled back into India sec 68(2)**
 In case of Goods likely to be smuggled back into India – CG may by *Notification in official gazette* direct that:
 --- Clearance without duty payment not permissible
 ---Clearance is permissible only subject to fulfillment of specified conditions or restrictions.

Allowance in case of volatile goods [Section 70]

- If any warehoused goods at the time of delivery from a warehouse are found to be deficient in quantity on account of natural loss, the AC/DC may remit the duty on such deficiency.
- This section applies to such warehoused goods as notified by the Central Government, having regard to the volatility of the goods and the manner of their storage.

Duty Drawback

Duty draw back means refund of customs duty, and excise duty paid on inputs/material to exporter on export

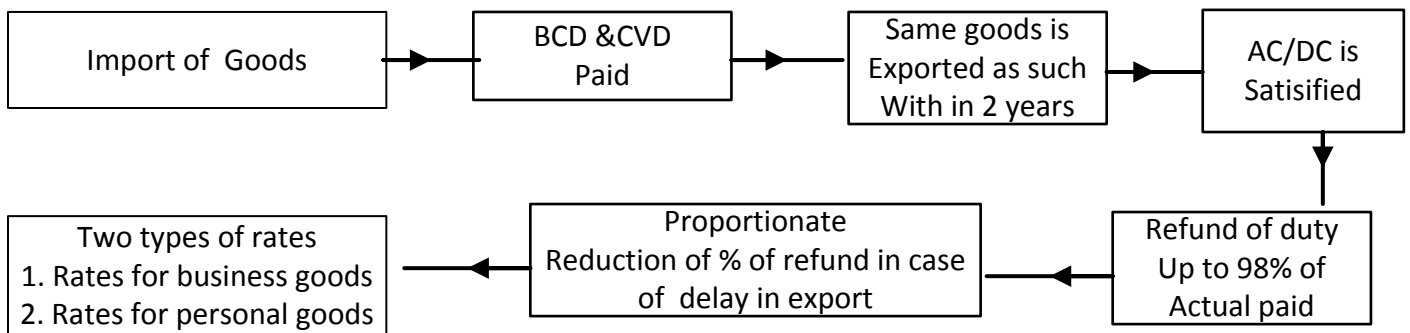
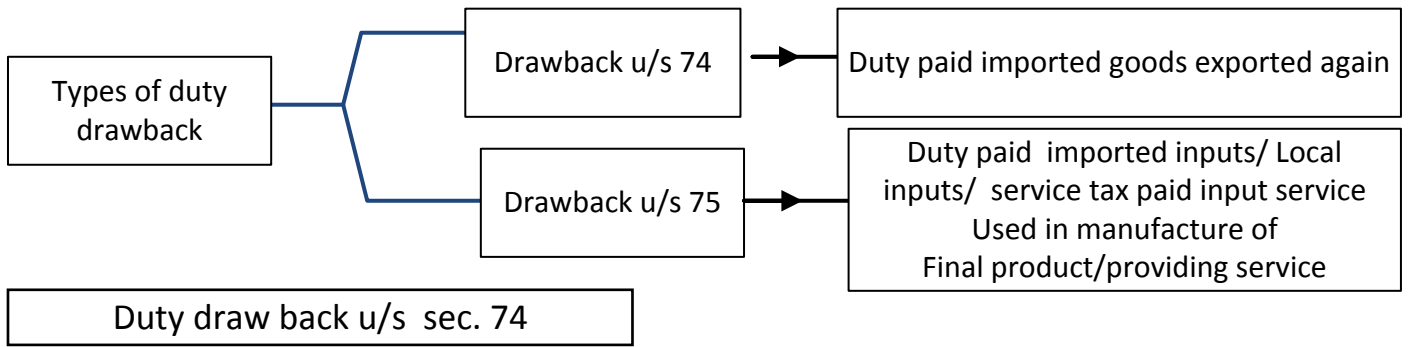

Duty draw back u/s sec. 75

CA N.Rajasekhar FCA,DISA(ICAI) Chennai
9444019860, rajdhost@yahoo.com

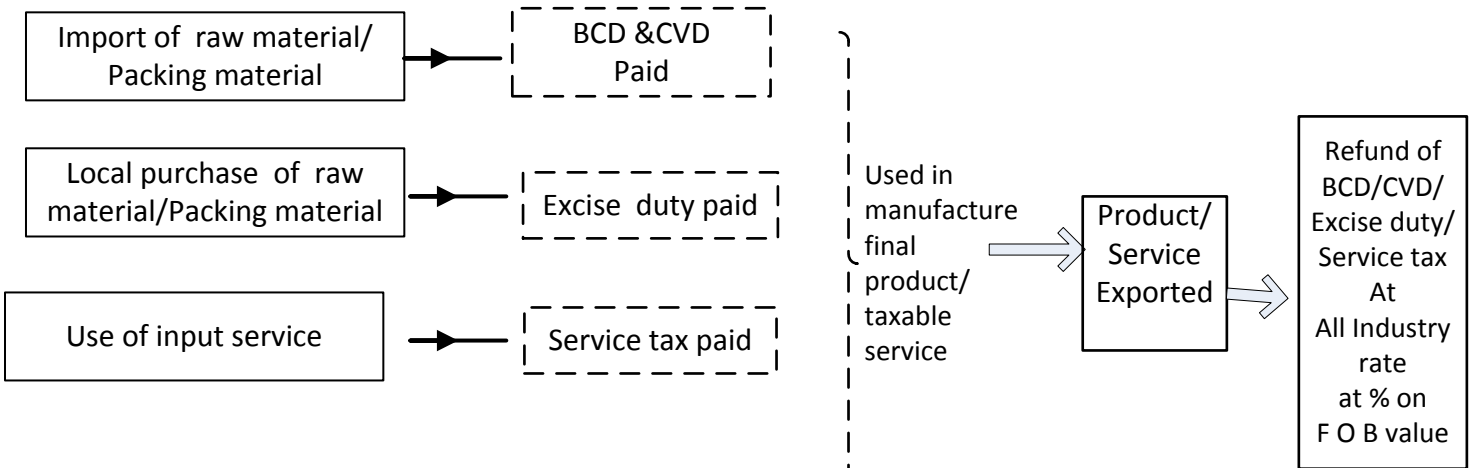

Rates of draw back

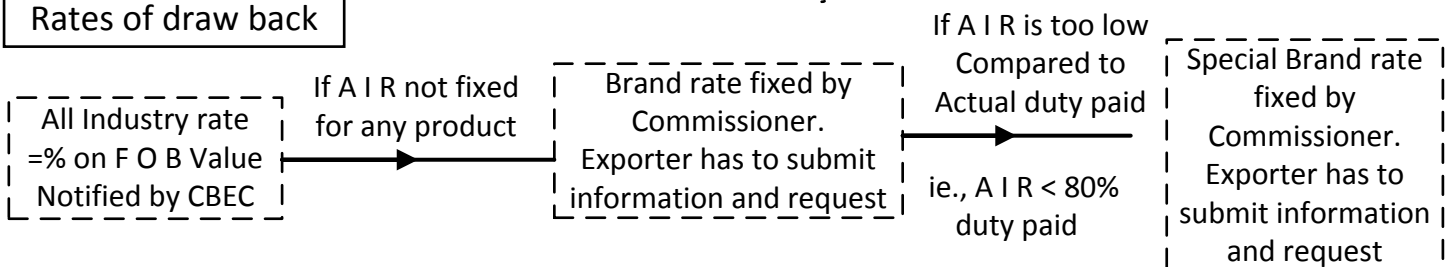

VAT (Value added Tax)-- Basic Concepts

Taxonomy of VAT (How VAT will work) / Stages of VAT

Example

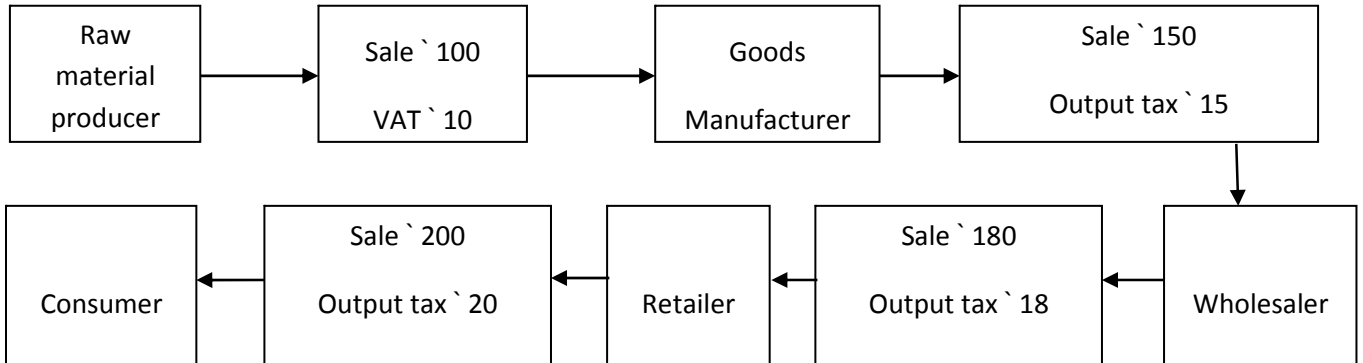

CA N.Rajasekhar FCA,DISA(ICAI) Chennai
9444019860, rajdhost@yahoo.com

S. No.	Dealer	Sale price	Value addition (VA)	Output tax @ 10% on sales	VAT Credit (input tax paid on purchases)	VAT payable to Govt. 10% on value addition	Multi-point taxation
1	Raw material manufacturer	100	-	10	-	-	Yes, on sales
2	Goods Manufacturer	150	50	15	10	5	Yes, on VA
3	Wholesaler	180	30	18	15	3	Yes, on VA
4	Retailer	200	20	20	18	2	Yes, on VA

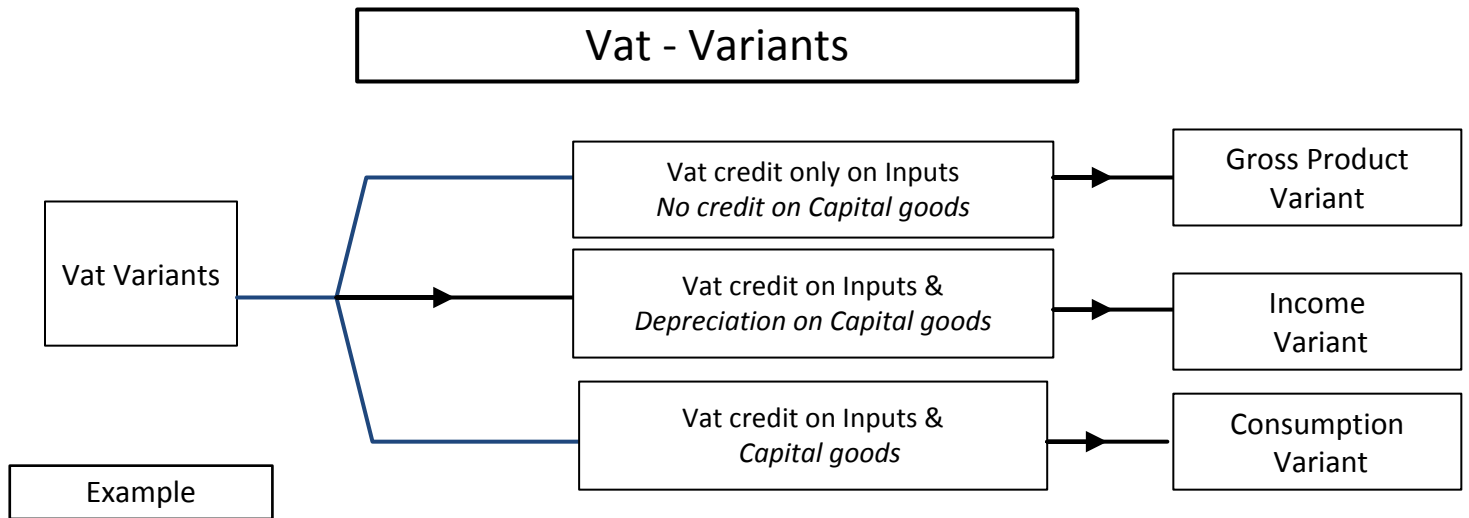

VAT payable under the three methods is as given below:

Particulars	Gross Product Variant (`)	Income Variant (`)	Consumption Variant (`)
VAT on Sales(Output tax)			
14.5% on 200 lakhs	29,00,000	29,00,000	29,00,000
Less: VAT On Purchases (INPUT tax)			
5% on 100 lakhs on raw material	5,00,000	5,00,000	5,00,000
Less: VAT on Capital goods	No credit		
5% x ` 300 lakhs x10%		1,50,000	
5% x ` 300 lakhs			15,00,000
NET VAT PAYABLE	24,00,000	22,50,000	9,00,000

CA N.Rajasekhar FCA,DISA(ICAI) Chennai
9444019860, rajdhost@yahoo.com

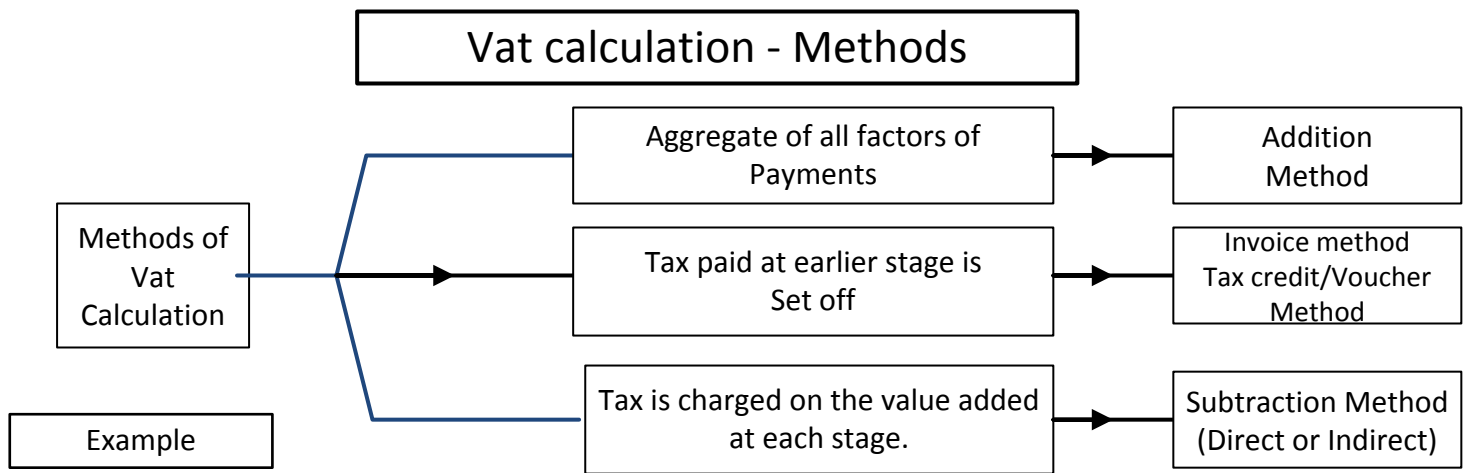

Illustration of Addition method:

(Assumption VAT rate is 10%)

Particulars	Mr. X (₹)	Mr. Y (₹)
<i>Purchase price including VAT 10%</i>	110	319
<i>Add: Value addition.</i>		
(Labour + Overheads + Depreciation + Profit)	190	131
<i>Add: Net VAT payable to Department on Value addition 10%</i>	19	13
Selling Price (Purchase price + value addition + Net VAT payable)= 110 + 190 + 19)	319	463

CA N.Rajasekhar FCA,DISA(ICAI) Chennai
9444019860, rajdhost@yahoo.com

Illustration of Invoice method:

Particulars	Mr. X (₹)	Mr. Y (₹)
<i>Purchase price excluding VAT 10%</i>	100	290
<i>Add: Value addition</i>		
(Labour + Overheads + Depreciation + Profit)	190	131
	290	421
<i>Add: VAT 10%</i>	29	42
Selling Price (Purchase price excluding VAT + value addition + VAT)= 110 + 190 + 19)	319	463
Net VAT payable to Department		
Output tax	29	42
Less: Input tax	10	29
	19	13

Illustrations of Subtraction method:

Intermediate Subtraction method

Particulars	Mr. X (₹)	Mr. Y (₹)
Selling Price inclusive of VAT 10%	319	463
Less: Purchase Price inclusive of VAT 10%	110	319
Value addition	209	144
VAT Computation For x – $209 \times 10/110$, for Y – $144 \times 10/110$	19	13

Direct Subtraction method

Particulars	Mr. X (₹)	Mr. Y (₹)
Selling Price Exclusive of VAT 10%	290	421
Less: Purchase Price Exclusive of VAT 10%	100	290
Value addition Exclusive of VAT	190	131
VAT Computation @10% of value addition	19	13

CA N.Rajasekhar FCA,DISA(ICAI) Chennai
9444019860, rajdhost@yahoo.com

Vat- Input tax, Output tax and input tax credit

Input tax means: VAT paid by a registered business dealer on taxable purchases for business. Purchases may include raw material, trading goods, capital goods and consumables

Output tax : This is the VAT charged by a registered business dealer on sales made by the business to its customers. It is a tax on sales within the state as well as outside the state (Central Sales Tax).

Input Tax Credit (ITC) : ● Input tax credit means the availability of credit on the input tax paid on purchases made by the dealer ● It is the setting-off of the amount of input tax paid by a registered dealer against the amount of his output tax payable on sales.

CA N.Rajasekhar FCA,DISA(ICAI) Chennai
9444019860, rajdhost@yahoo.com

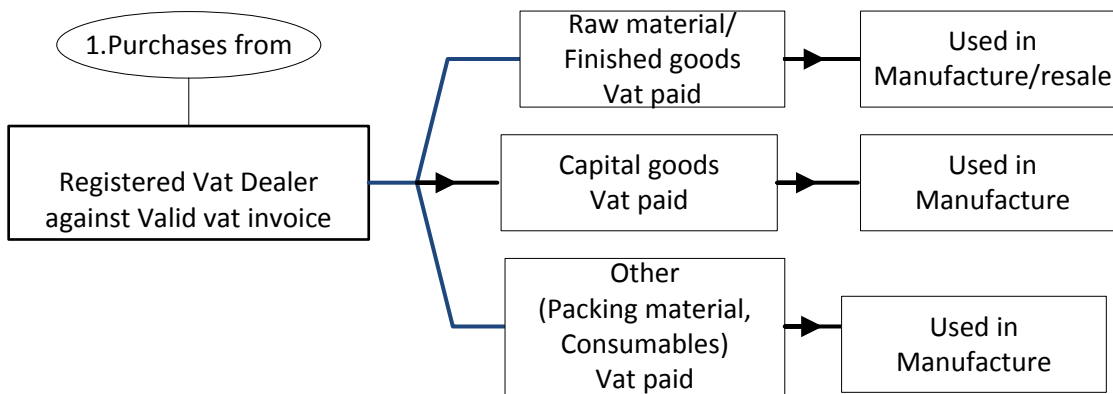

Output tax payable =
Vat payable in Sales with in state/CST payable on outside state sales or Interest/ Penalty under vat
Utilise Input credit and pay balance vat if any

Carry forward of Input Tax Credit

- Input tax credit is first to be utilised for the payment of VAT
- The excess credit can be then adjusted against the central sales tax (CST)
- After the adjustment of VAT and CST, excess credit, if any, will be carried over to the end of the next financial year

Input tax credit on stock transfers

Vat paid goods transferred to branch etc Vat credit available in excess of 4%

Refund of input tax to exporter within three months

- Vat paid on purchases which are exported, the credit can be utilised/adjusted towards payment of VAT on goods sold within the state/outside the state
- If such an adjustment is not possible, refund is to be with in three month from the date of export e.

Purchases not eligible for input tax (No input tax credit)

- Purchases are made from unregistered dealers;/from a registered dealer who opts for the composition scheme ;
- Negative list goods, For example petrol, diesel, CNG, LPG, , etc.;
- Purchase of goods, where the invoice does not show the amount of tax separately;
- Purchase of goods, which are being utilized in the manufacture of exempted goods other than exports;
- Purchase of goods used for personal use/ consumption, or goods provided free of charge as gifts;
- Goods imported from outside the territory of India (commonly known as high seas purchases);
- Goods purchased from other States (inter-State purchases).

Vat in case of Special Transactions

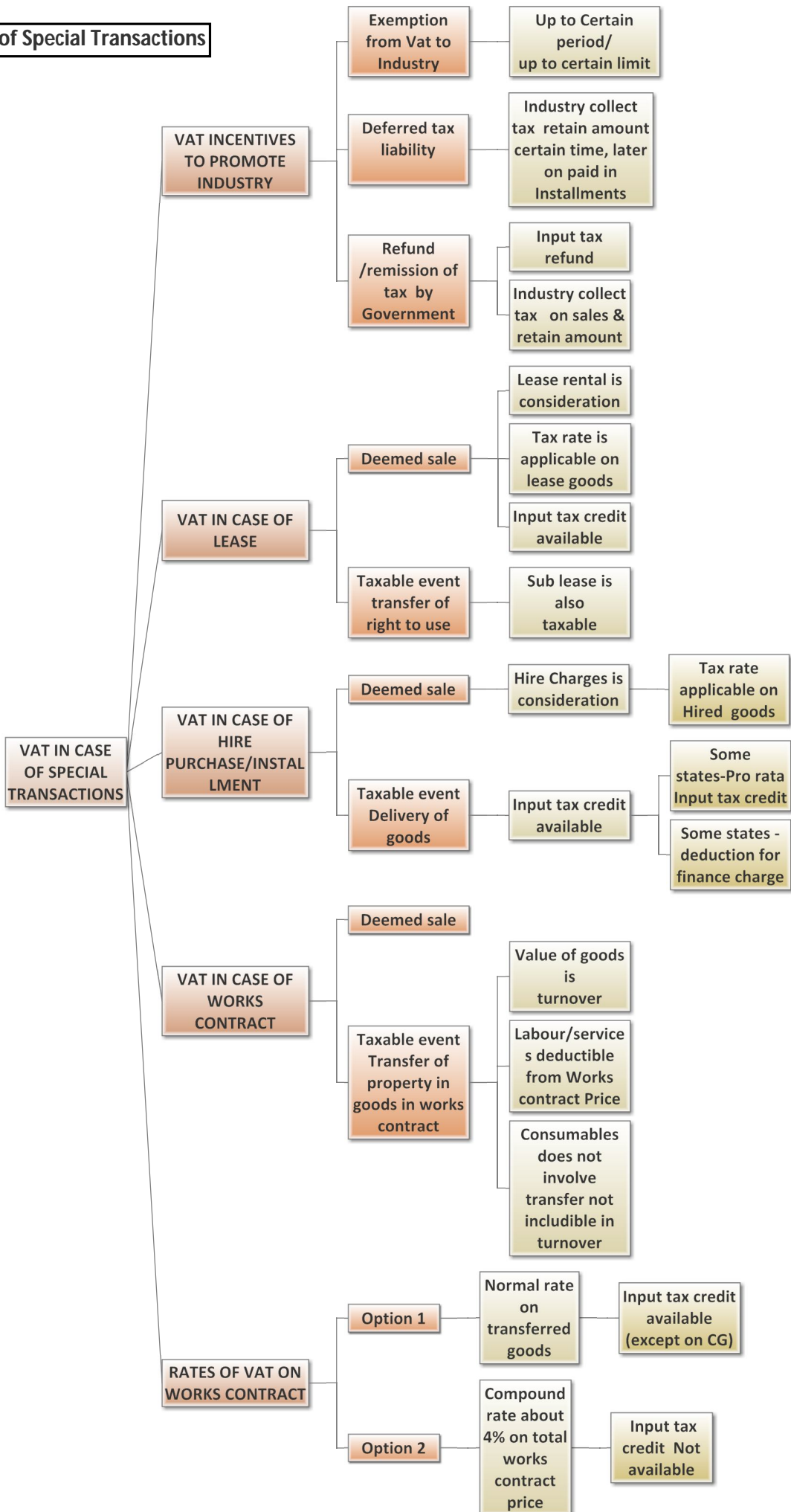

Service Tax - Basics 1

Service Definition

Sec 65B (44)

- Activity for consideration From one person to other
- Service include Declared Service
- Service exclude
 - Sale transaction (both movable and immovable)
 - Deemed sale transaction (lease, Hp, Material portion of works contract etc)
 - Services of employee
 - Transactions only in money
 - Services of MP, MLA, MLC, Govt. Nominated persons /Constitution posts,
 - Services of tribunal court (appeal fee is not a consideration)

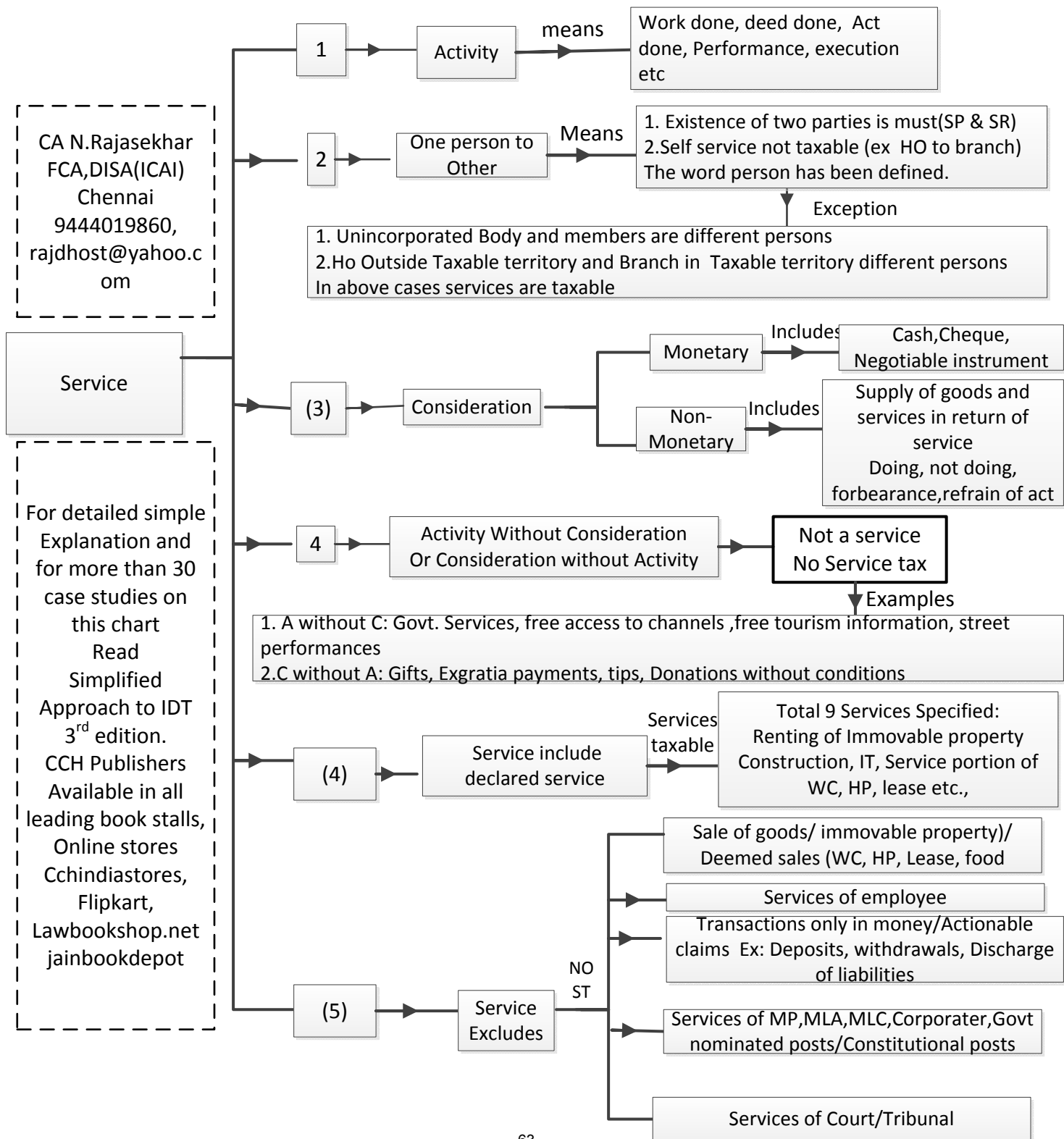

CA N.Rajasekhar
FCA, DISA (ICAI)
Chennai
9444019860,
rajdhost@yahoo.com

Service

For detailed simple Explanation and for more than 30 case studies on this chart Read Simplified Approach to IDT 3rd edition. CCH Publishers Available in all leading book stalls, Online stores Cchindiastores, Flipkart, Lawbookshop.net jainbookdepot

Service Tax Charging Section

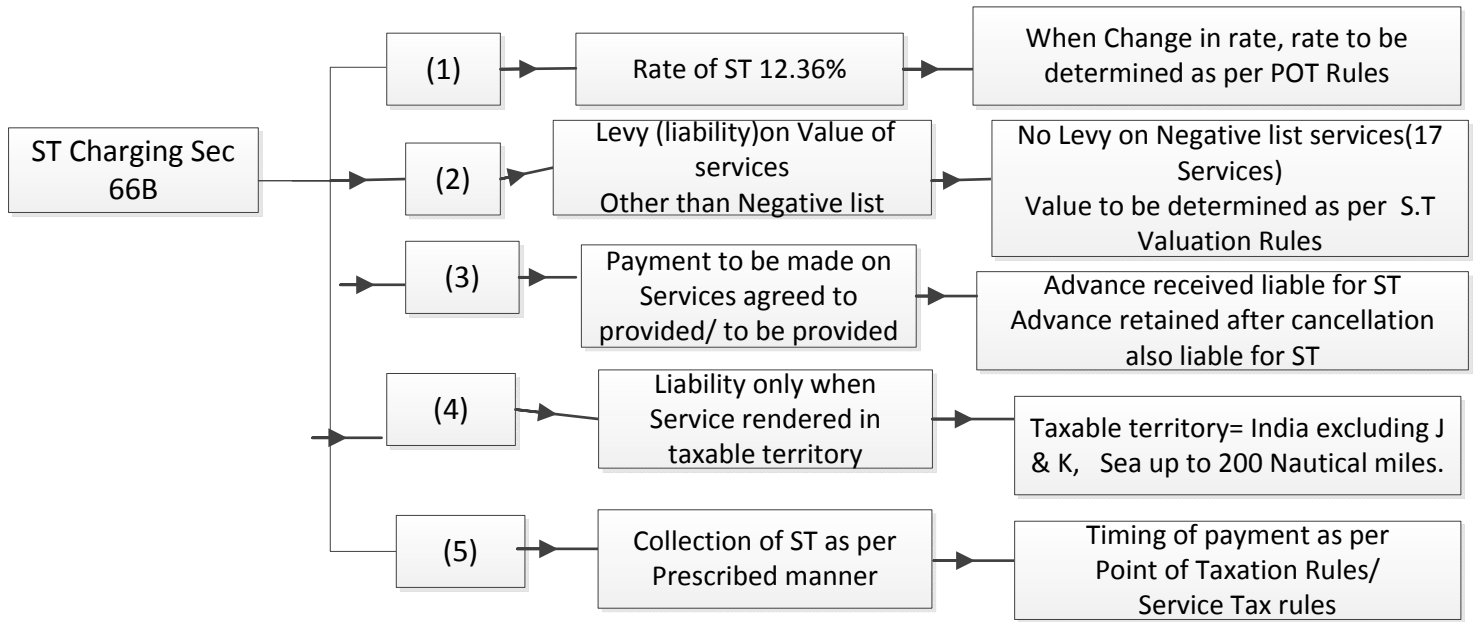

ST- Interpretation /Classification- Sec 66 F

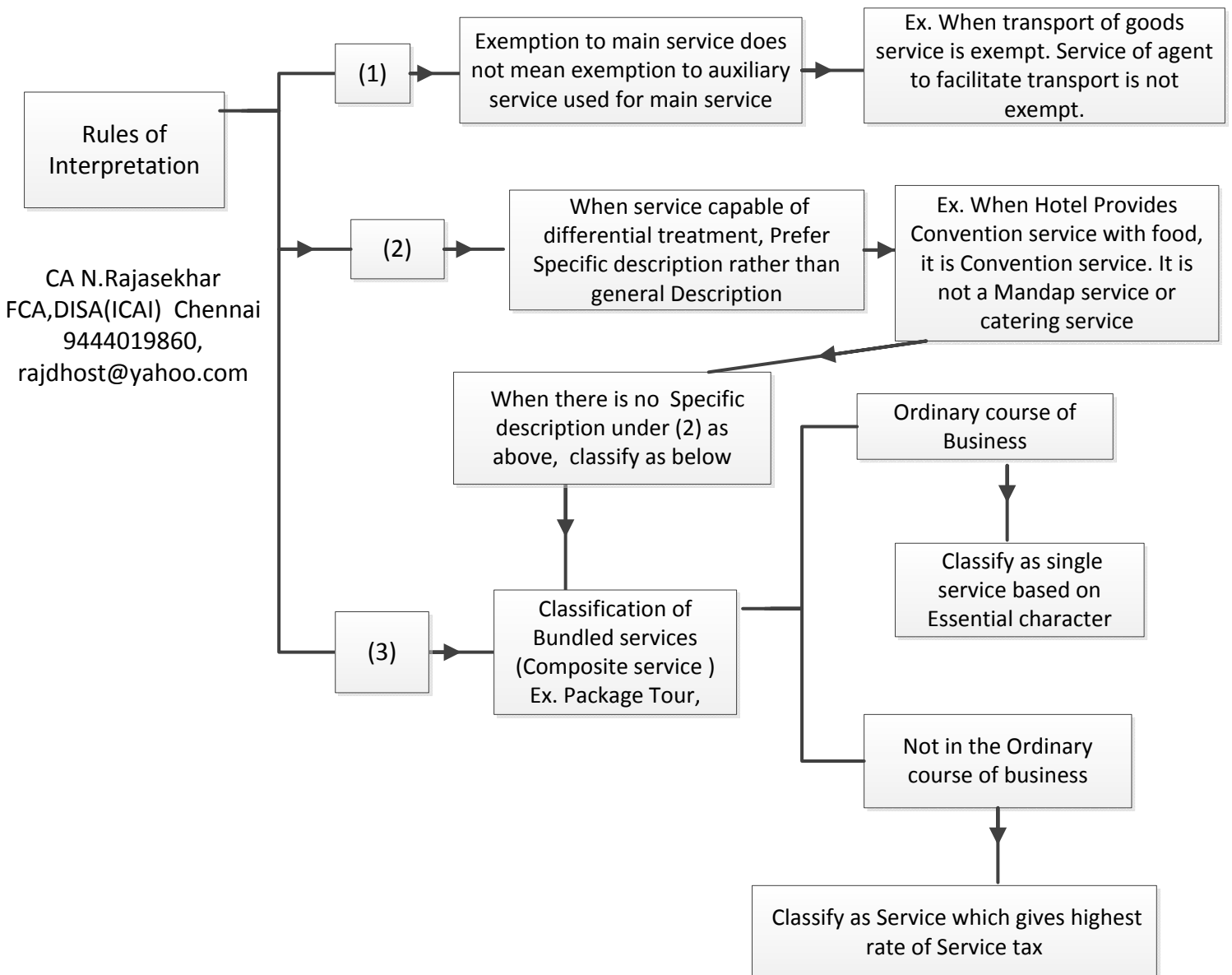

CA N.Rajasekhar
FCA,DISA(ICAI) Chennai
9444019860,
rajdhost@yahoo.com

Determination of provision of service and taxability

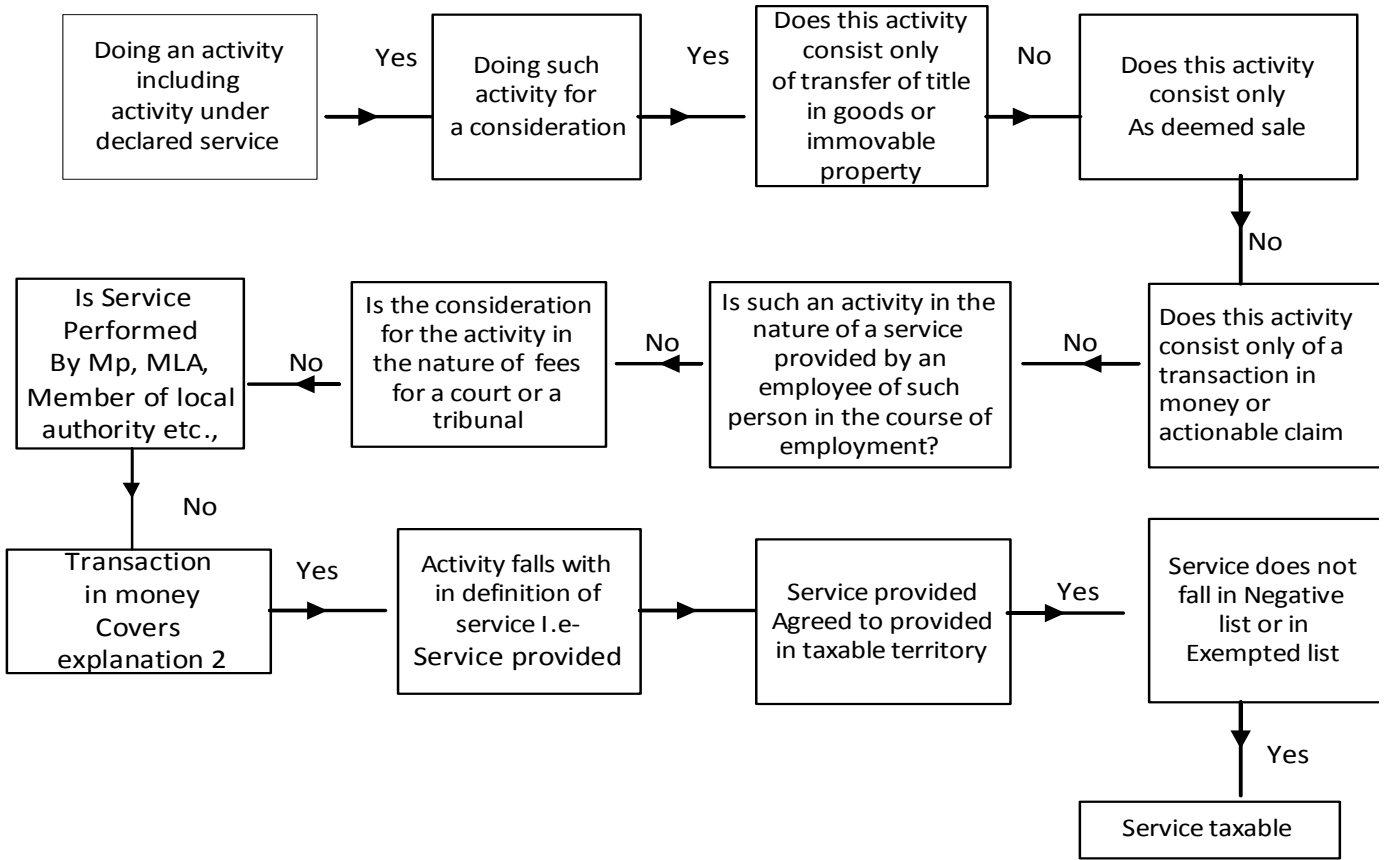

Declared Services/Negative List/Exempted Services

I. Renting of Immovable Property

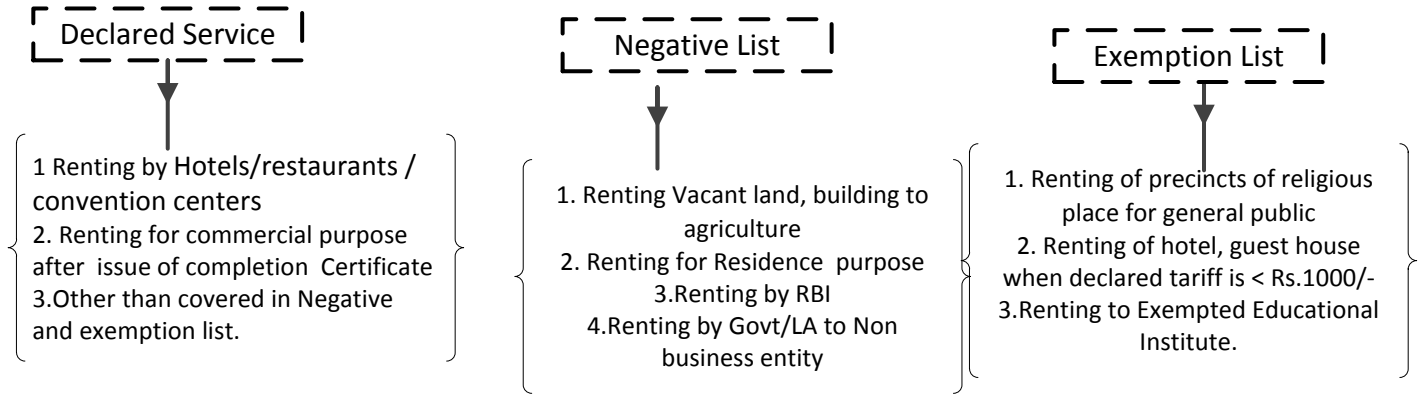

Case Studies

Description	Nature of service	Taxability
Renting of property to an educational body	Exempted service if education body is exempted service	Not taxable
Renting of vacant land for animal husbandry or floriculture	Negative list	Not taxable
Permitting use of immovable property for placing vending/dispensing machines	Declared Service	Taxable
Allowing erection of a communication tower on a building for consideration	Declared Service	Taxable
Renting of land or building for entertainment or sports	Declared Service	Taxable
Renting of theatres by owners to film distributors (including under a profit-sharing arrangement)	Declared Service	Taxable
Letting out their halls, rooms etc. for social, official or business functions or letting out of halls for cultural function	Declared Service	Taxable

2. Construction of a complex, building, civil structure or a part thereof

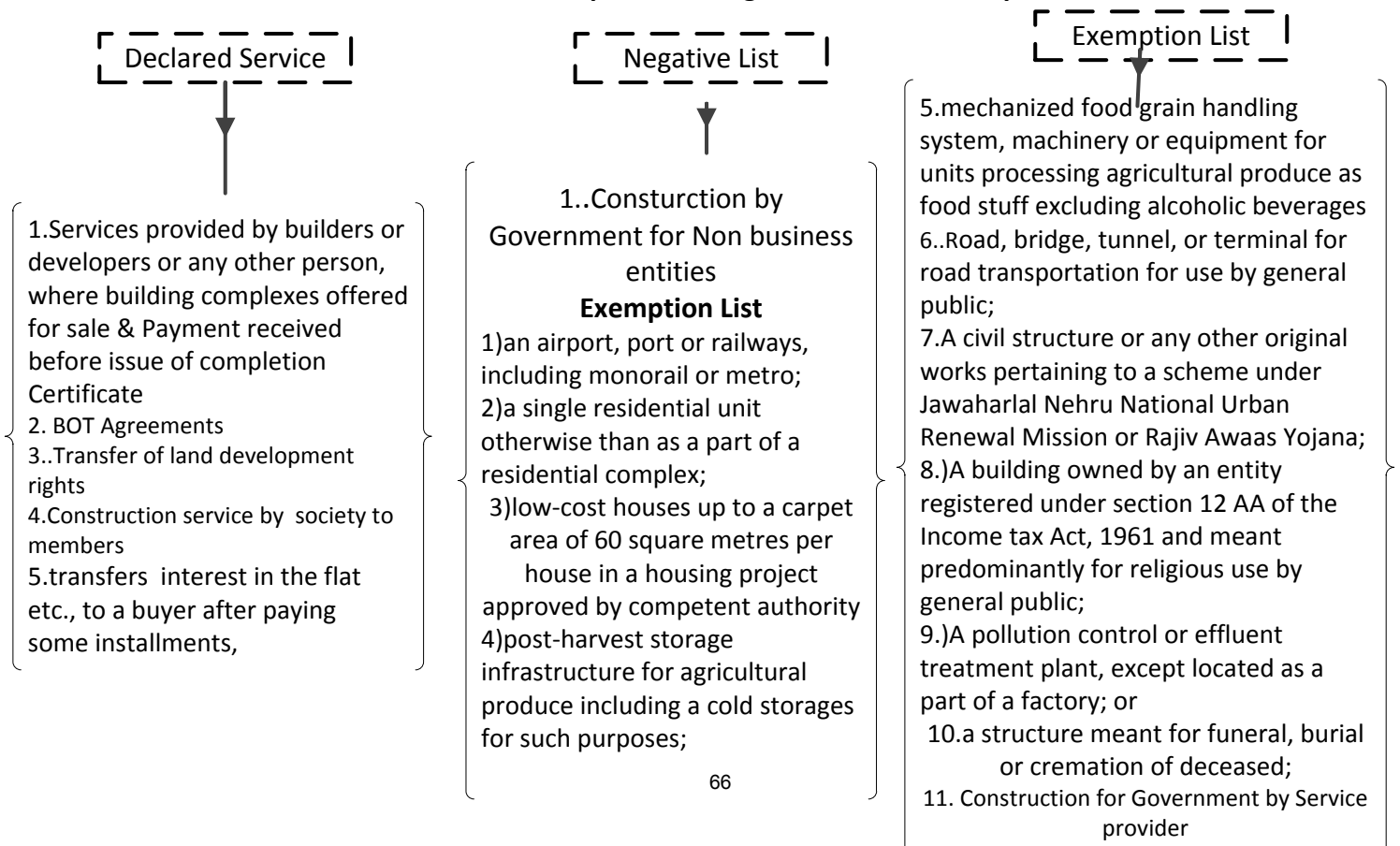

Declared Services/Negative List/Exempted Services

3.. Temporary transfer or permitting the use or enjoyment of any intellectual property right

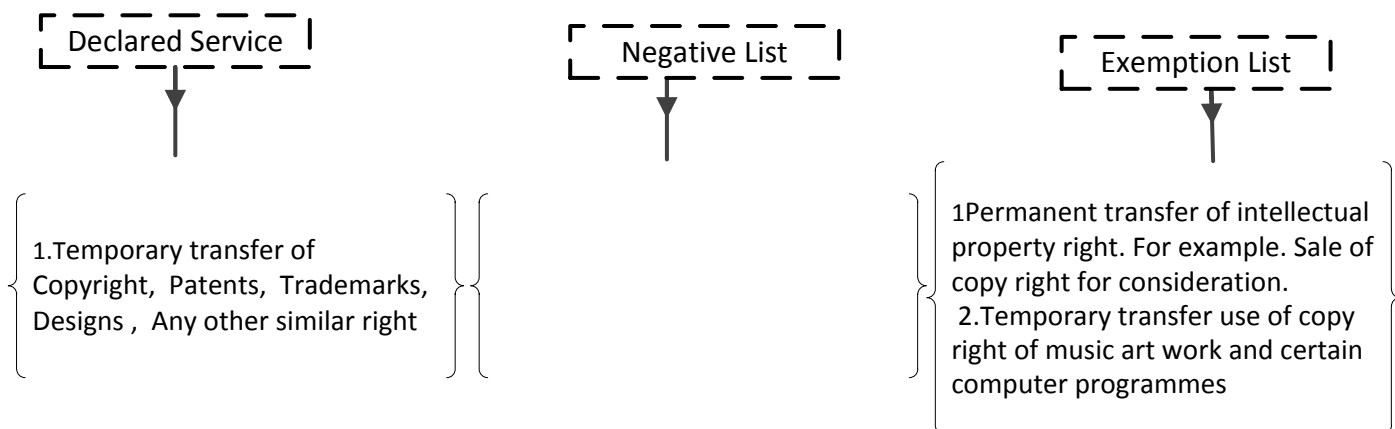

Case Studies

Description	Nature of service	Taxability
music company having the copyright of music sound recording transfers its right temporarily of distributing music	Declared service. falls under Sec 13(1) (c) of Copy right	Taxable
A composer of a song having the copyright for his own song. He allows the recording of the song on payment of some royalty by a music company for further distribution	Exemption list falls under Sec 13(1) (a) of Copy right	Not taxable
Mr. Raj an author, having copy right of an Indirect tax book. He received royalty from the M/s CH publishers for publishing the book written by him	Exemption list falls under Sec 13(1) (a) of Copy right	Not taxable
M/S RR Moviemakers having a copy right of a cinematographic film	Exemption list falls under Sec 13(1) (b) of Copy right	Not taxable

4. Development, design, programming, customization, adaptation, up gradation, enhancement, implementation of information technology software

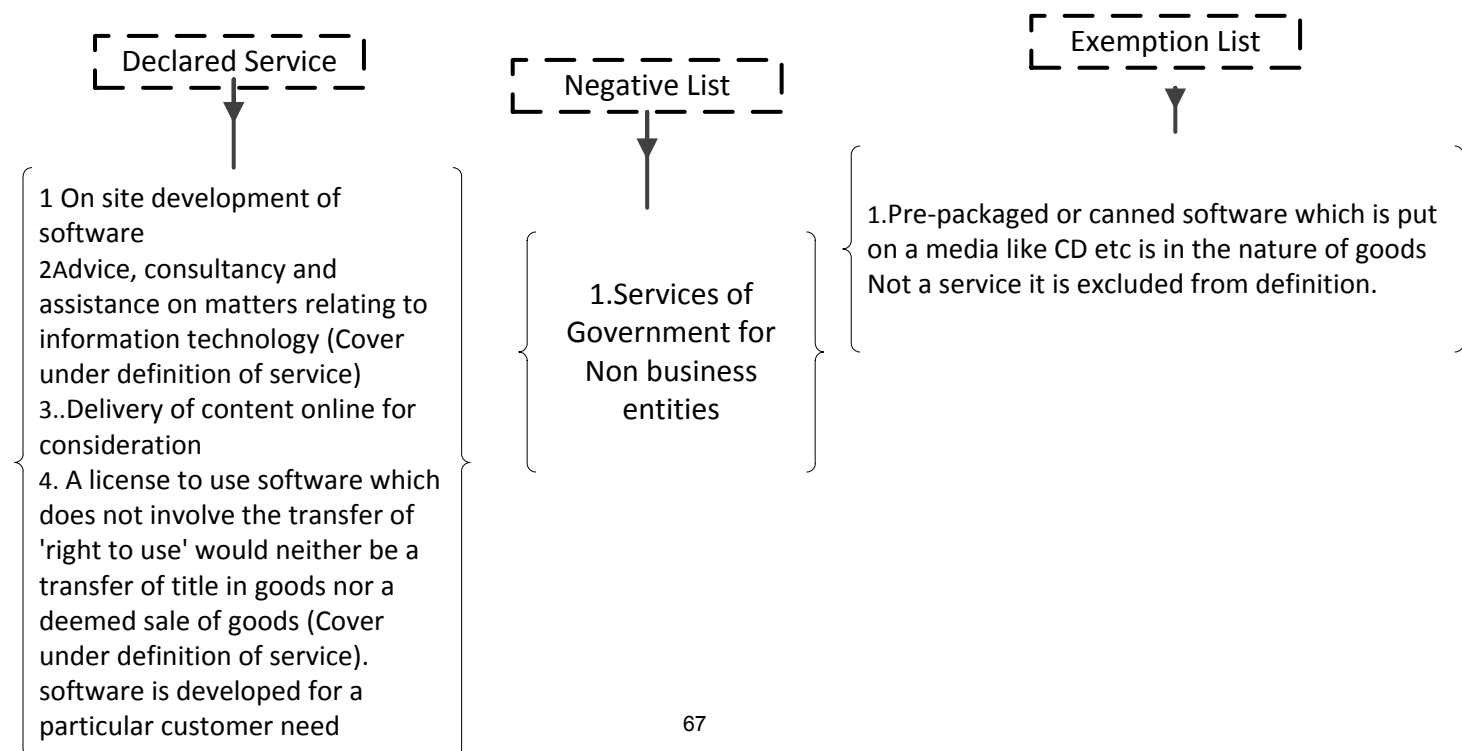

Declared Services/Negative List/Exempted Services

Agreeing to the obligation to refrain from an act, or to tolerate an act or a situation, or to do an act

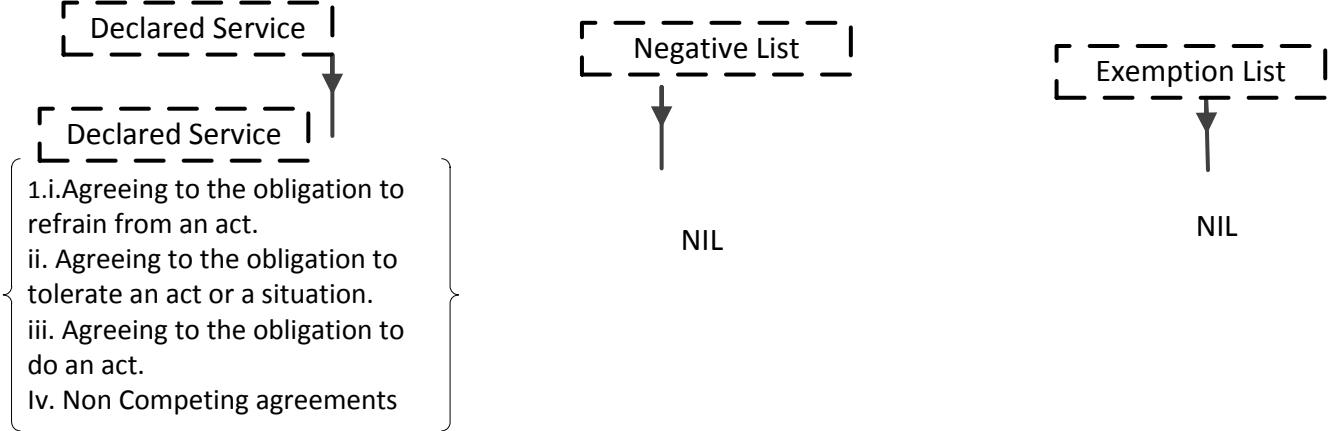

Transfer of goods by way of hiring, leasing, licensing or any such manner without transfer of right to use such goods

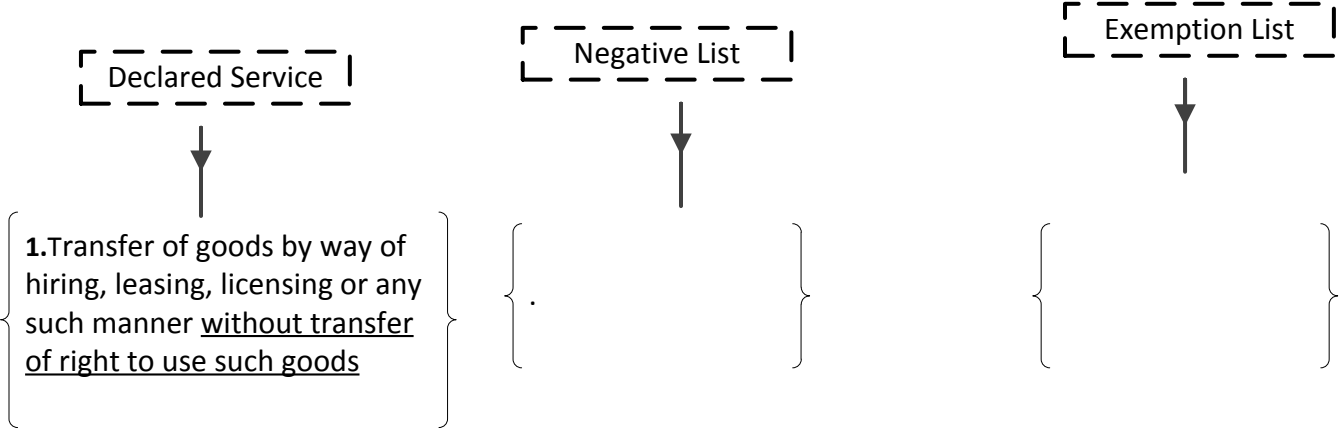

S.No.	Nature of transaction	Whether transaction involves transfer of right to use	Taxability
1.	A car is given in hire by a person to a company along with a driver on payment of charges on per month/mileage basis	Right to use is not transferred. The service is, therefore covered in the declared list entry.	Taxable
2.	Supply of equipment like excavators, wheel loaders, dump trucks, cranes, etc for use in a particular project where the person to whom such equipment is supplied is subject to such terms and conditions in the contract relating to the manner of use of such equipment return of such equipment after a specified time, maintenance and upkeep of such equipment.	The transaction will not involve transfer of right to use such equipment as in terms of the agreement the possession and effective control over such equipment has not been transferred even though the custody may have been transferred along with permission to use such equipment..	Taxable
3.	Hiring of bank lockers	The transaction does not involve the right to use goods as possession of the lockers is not transferred to the hirer).	Taxable
4.	Hiring out of vehicles where it is The responsibility of the owner to abide by all the laws relating to motor vehicles	No transfer of right to use goods as effective control and possession is not transferred (Allahabad High Court judgement in <i>Ahuja Goods Agency v. State of UP</i> [(1997)106STC540] refers)	Taxable
5.	Hiring of audio visual equipment where risk is of the owner	No transfer of right to use goods as effective control and possession is not transferred	Taxable

Declared Services/Negative List/Exempted Services

. Activities in relation to delivery of goods on hire purchase or any system of payment by installments

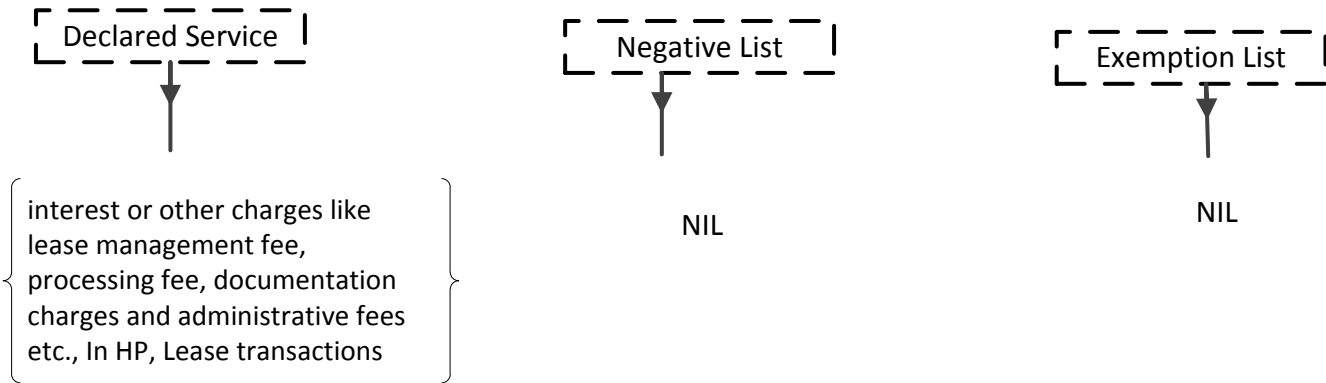

Transfer of goods by way of hiring, leasing, licensing or any such manner without transfer of right to use such goods

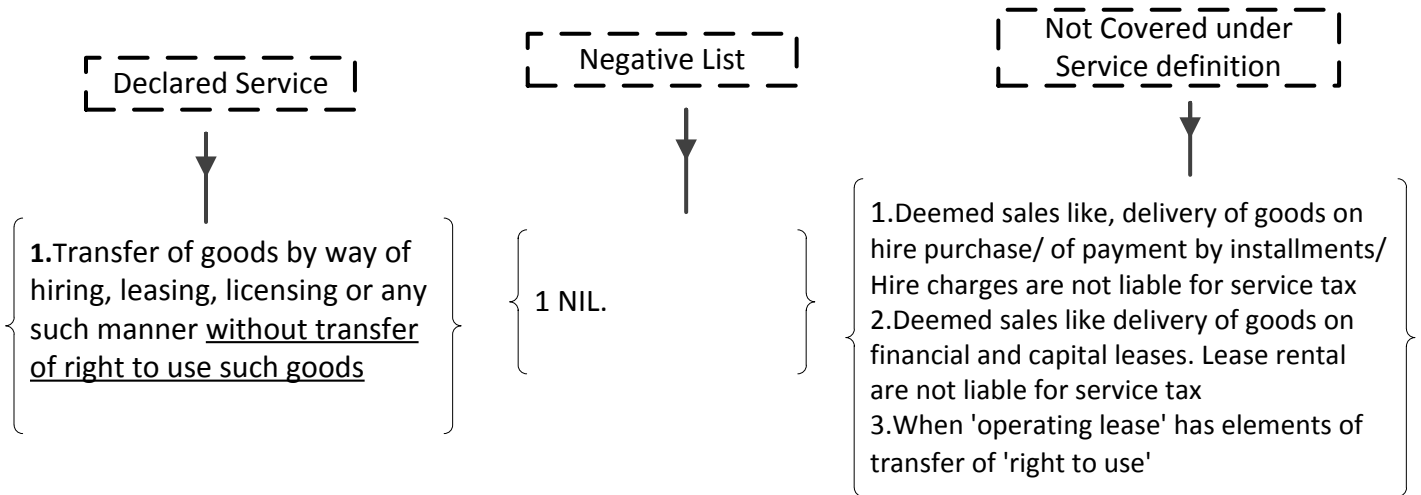

Service portion in an activity wherein goods, being food or any other article of human consumption or any drink (whether or not intoxicating) is supplied in any manner as part of the activity

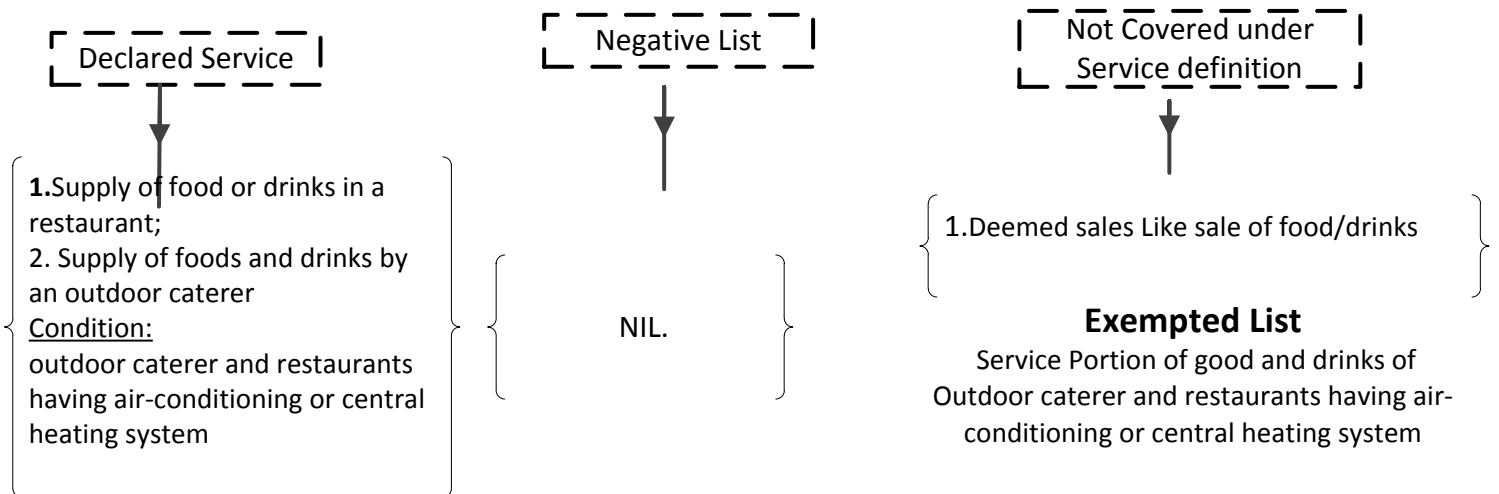

Declared Services/Negative List/Exempted Services

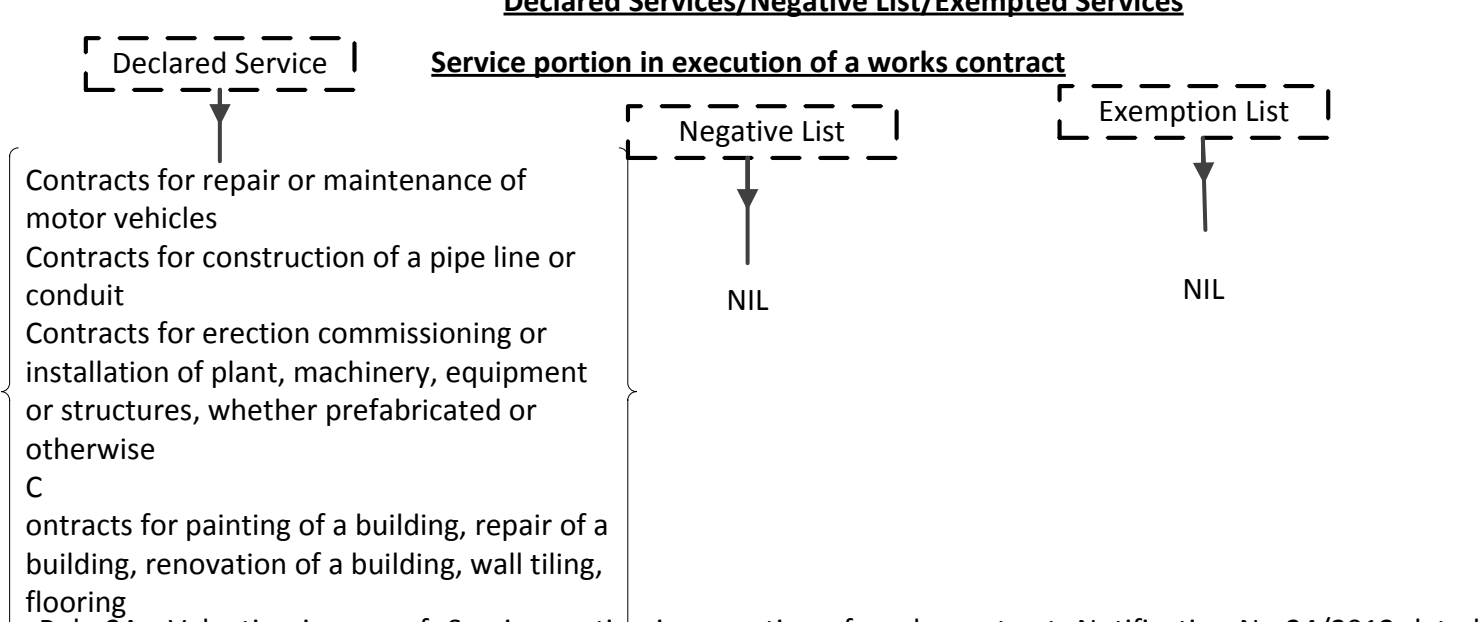

Rule 2A - Valuation in case of Service portion in execution of works contract Notification No 24/2012 dated 0606.2012 with effect from 1.07.2012

• This valuation rule is the subject the provisions of section 67 with regard to valuation.. It implies, the provision of the meaning of gross amount, consideration, and determination when service tax not collected will be applicable as per sec 67.

• The value in case of service portion in execution of works contract is:

Gross amount charged	Xxxx
Less: Value of transfer of property in goods involved in execution of contract	Xxxx
Value of works contract service	Xxxx

Exclusions in the gross amount charged

VAT/sales tax paid on transfer of property in goods involved in execution of contract

Inclusions in the gross amount charged

- Labour charges for execution of the works;
- Amount paid to a sub-contractor for labour and services;
- Charges for planning, designing and architect's fees;
- Charges for obtaining on hire or otherwise, machinery and tools used for the execution of the works contract;
- Cost of consumables such as water, electricity, fuel, used in the execution of the works contract;
- Cost of establishment of the contractor relating to supply of labour and services;
- Other similar expenses relating to supply of labour and services; and
- Profit earned by the service provider relating to supply of labour and services.

Value of transfer of property in goods involved in execution of contract

Where Value Added Tax or sales tax, as the case may be, has been paid on the actual value of transfer of property in goods involved in the execution of the works contract, then such value should be considered as the value of transfer of property in goods involved in execution of the said works contract for determining valuation of goods in this rule.

Alternative valuation when value cannot be determined as above.(Composition Scheme)

When the value of goods involved in the works contract is not ascertainable or not available, the value can be determined on the slab rate system as below:

Where works contract is for...	Value of the service portion shall be...
(A) execution of original works	40% of the total amount charged for the works contract
(B) maintenance or repair or reconditioning or restoration or servicing of any goods	70% of the total amount charged for the works contract
(C) in case of other works contracts, not included in serial nos. (A) and (B) above, including contracts for maintenance, repair, completion and finishing services such as glazing, plastering, floor and wall tiling, installation of electrical fittings.	60% of the total amount charged for the works contract

Total amount means

Particulars	Amount
Total of the gross amount charged	xxxxxxx
Add: the fair market value of all goods and services supplied by the recipient(s) in/in relation to the service, whether or not under Same contract	xxxxxxx
Less: the amount charged for such goods or services supplied to the service provider, if any	xxxxxxx
Less: the value added tax or sales tax, if any, levied thereon	xxxxxxx
Total amount	xxxxxxx

Example on determination on service portion in execution of works contract

The manner of arriving at the 'total amount charged' is explained with the help of the following example pertaining to works contract for execution of 'original works'.

S. No.	NOTATION	AMOUNT (in Rs.)
1	Gross amount received excluding taxes	95,00,000
2	Fair market value of goods supplied by the service receiver excluding taxes	10,00,000
3	Amount charged by service receiver for 2	5,00,000
4	Total amount charged (1 + 2 - 3)	1,00,00,000
5	Value of service portion(40% of 4 in case of original works)	40,00,000

Note:

fair market value of the goods or services so supplied shall be determined in accordance with the generally accepted accounting principles

Abatement in case of works contract

❖ Where the gross amount includes value of land, abatement can be claimed @75% and service tax can be payable on 25% of the gross amount as per notification no 26/2012-ST dated 20/6/12

Exempted Services 1

Charitable activities

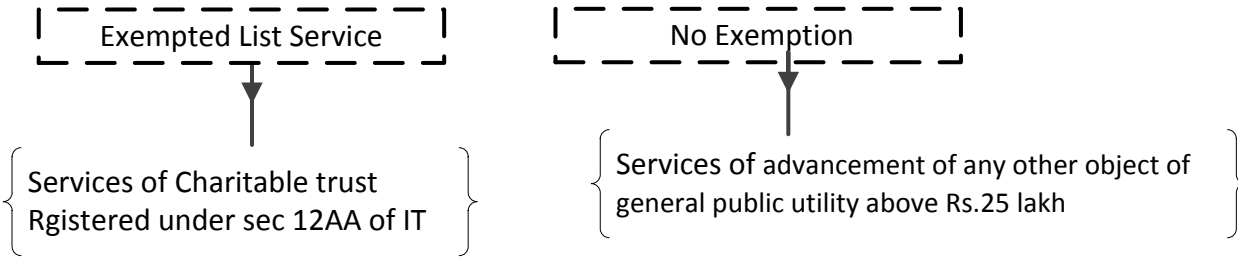

Advocate or Arbitral Tribunals' Services

Coverage of exemption

I. Service provider is arbitral tribunal

S No	Service receiver who is	Taxability
1	any person other than a business entity	Exempt
2	business entity with a turnover up to rupees ten lakh in the preceding financial year;	Exempt
3	business entity with a turnover exceeding rupees ten lakh in the preceding financial year;	No exemption. Taxable

II. Service Provider who is of Individual advocate/Firm of advocates

S No	Service receiver who is	Taxability
1	Individual advocate/Firm of advocates	Exempt
2	any person other than a business entity	Exempt
3	business entity with a turnover up to rupees ten lakh in the preceding financial year;	Exempt
4	business entity with a turnover exceeding rupees ten lakh in the preceding financial year;	No exemption. Taxable

II. Service provider is of person representing arbitral tribunal

S No	Service receiver who is	Taxability
1	arbitral tribunal	Exempt

Educational services

S no	Service provider	Service receiver	Transaction	Taxability
1	Exempted educational institute(where educational service is exempted)	Any person	a) Consideration from auxiliary education services from (a) to (e) above (b)Consideration from renting of immovable property	Exempt
2	Any person	Exempted educational institute(where educational service is exempted)	a) Consideration from auxiliary education services from (a) to (e) above (b)Consideration from renting of immovable property	Exempt

Exempted Services 2

Services provided to a recognised sports body

S no	Service provider	Service receiver	Transaction	Taxability
1	individual as a player, referee, umpire, coach or team manager	recognised sports body	Participation in a sporting event organized by a recognized sports body	Exempt
2	recognised sports body	recognised sports body	Any service	Exempt
3	individuals such as selectors, commentators, curators, technical experts	recognised sports body	participation in a sporting event organized by a recognized sports body	Taxable
4	individual as a player, referee, umpire, coach or team manager	IPL	participation in a sporting event	Taxable

Construction Services - Services provided to the Government or local authority

Service Provider	Any person
Service receiver	Government, Local authority, Governmental body
Nature of service	construction, erection, commissioning, installation, completion, fitting out, repair, maintenance, renovation, or alteration of the description of (a) to (f) below
Taxability	Service is exempt.

- ❖ Services provided to the Government, a local authority or a governmental authority by way of construction, erection, commissioning, installation, completion, fitting out, repair, maintenance, renovation, or alteration of-
- a) a civil structure or any other original works meant predominantly for use other than for commerce, industry, or any other business or profession;
 - b) a historical monument, archaeological site or remains of national importance, archaeological excavation, or antiquity specified under the Ancient Monuments and Archaeological Sites and Remains Act, 1958 (24 of 1958);
 - c) a structure meant predominantly for use as
 - (i) an educational,
 - (ii) a clinical, or
 - (iii) an art or cultural establishment;
 - d) canal, dam or other irrigation works;
 - e) pipeline, conduit or plant for (i) water supply (ii) water treatment, or (iii) sewerage treatment or disposal; or
 - f) a residential complex predominantly meant for self-use or the use of their employees or MPs., MLAs., Members of local authority

Exempted Services 3

Specified Construction services

- ❖ Services provided by way of construction, erection, commissioning, installation, completion, fitting out, repair, maintenance, renovation, or alteration of,-
 - a) a road, bridge, tunnel, or terminal for road transportation for use by general public;
 - b) a civil structure or any other original works pertaining to a scheme under Jawaharlal Nehru National Urban Renewal Mission or Rajiv Awaas Yojana;
 - c) a building owned by an entity registered under section 12 AA of the Income tax Act, 1961 (43 of 1961) and meant predominantly for religious use by general public;
 - d) a pollution control or effluent treatment plant, except located as a part of a factory; or
 - e) a structure meant for funeral, burial or cremation of deceased;

Coverage

Service Provider	Any person
Service receiver	Any person
Nature of service	construction, erection, commissioning, installation, completion, fitting out, repair, maintenance, renovation, or alteration of the description of (a) to (e) above
Taxability	Service is exempt.

Construction Services - Original works – Others

Scope of Exempt Service –

- ❖ Services by way of construction, erection, commissioning, or installation of original works pertaining to,-
 - a) an airport, port or railways, including monorail or metro;
 - b) a single residential unit otherwise than as a part of a residential complex;
 - c) low-cost houses up to a carpet area of 60 square metres per house in a housing project approved by competent authority empowered under the 'Scheme of Affordable Housing in Partnership' framed by the Ministry of Housing and Urban Poverty Alleviation, Government of India;
 - d) post-harvest storage infrastructure for agricultural produce including a cold storages for such purposes; or
 - e) mechanized food grain handling system, machinery or equipment for units processing agricultural produce as food stuff excluding alcoholic beverages;

Service Provider	Any person
Service receiver	Any person
Nature of service	construction, erection, commissioning, or installation of original works of the description of (a) to (e) above
Taxability	service is exempt.

Renting of a hotel, inn, guest house, club, campsite or other commercial places

Service	Renting of a hotel, inn, guest house, club, campsite or other commercial places meant for residential or lodging purposes
Exemption	When declared tariff <=Rs.1000/-

Serving of food or beverages by a restaurant, eating joint or a mess

Service provider	Restaurant, eating joint or a mess,
Service	Serving of food or beverages
Taxability	service is exempt
Exemption not available(Taxable)	(i) Restaurant, eating joint or a mess has the facility of air-conditioning or central air-heating in any part of the establishment, at any time during the year and
	(ii) Restaurant, eating joint or a mess has a licence to serve alcoholic beverages.

Goods transport agency

Service provider	Goods transport agency
Service	Transportation of goods fruits, vegetables, eggs, milk, food grains or pulses
Taxability	Service is exempt.

Coverage 2.

Service provider	Goods transport agency
Service	Transportation of any goods
Value based exemption	gross amount charged single goods carriage <=Rs.1500/-
	gross amount charged for all goods of single consignee <=Rs.750/-

|| Renting of Motor Vehicle for transportation of passengers and goods

Scope of Exempt Service –

- ❖ Services by way of giving on hire-
 - a) to a state transport undertaking, a motor vehicle meant to carry more than twelve passengers; or
 - b) to a goods transport agency, a means of transportation of goods

Transport of passengers

Service Provider	Any person
Service	Transportation of passengers with or without belongings
Transport through	By air from and to North eastern states, Bagdogra of West Bengal
	Contract carriage Excluding tourism, conducted tour, charter or hire ropeway, cable car or aerial tramway
Taxability	Service exempt

Motor vehicle parking to general public

Service	vehicle parking to general public
Taxability	Service is exempt.

Coverage 2

Service	Leasing of land for providing parking facility
Taxability	Service is taxable.

Service by a club/association/society to own members

Coverage 1:

Service Provider	Registered trade union
Service	To its own members by way of reimbursement of charges or share of contribution
Taxability	Exempt

Coverage 2:

Service Provider	Registered unincorporated body or a non- profit entity
Service	To its own members by way of reimbursement of charges or share of contribution, for the provision of carrying out any activity which is exempt from the levy of service tax
Taxability	Exempt

Coverage 3:

Service Provider	Registered unincorporated body or a non- profit entity
Service	To its own members by way of reimbursement of charges or share of contribution,
Taxability	Exempt up to an amount of Rs.5000/- per month per member for sourcing of goods or services from a third person for the common use of its members in a housing society or a residential complex

Services provided by person located in a non- taxable territory

Service provider	Service receiver	Taxability
Person located in Nontaxable territory	Government, a local authority, a governmental authority	Exempt
Person located in Nontaxable territory	Individual receiving service for personal purpose	Exempt
Person located in Nontaxable territory	Person located in Nontaxable territory	Exempt

Health Care services**Coverage (Exempted and not taxable)**

- Health care Services rendered by doctors, hospitals, clinics, sanatoriums, paramedics, labs for diagnosis, treatment for illness, injury, deformity, abnormality and pregnancy.
- Plastic/Cosmetic Surgery when undertaken to restore or to reconstruct anatomy or functions of body affected due to congenital defects, developmental abnormalities, injury or trauma

Not covered (taxable)

Health care services of hair transplant or cosmetic or plastic surgery

Renting of precincts of a religious place or conduct of any religious ceremony**Scope of Exempt Service -**

Services by a person by way of-

Renting of precincts of a religious place *meant for general public*; or conduct of any religious ceremony

Exempted Services 4

Training or coaching in recreational activities

Scope of Exempt Service -

- Services by way of training or coaching in recreational activities relating to arts, culture or sports.

Coverage

- a) Services by way of training or coaching.
- b) Coaching should be in recreational activities (Activity of entertainment, enjoyment, refreshment).
- c) Such coaching relating to arts, culture or sports.

Copyright

Coverage:

Service Provider	Any person
Service receiver	Any person
Nature of service	Temporary transfer or permitting the use or enjoyment of a copyright (a)original literary, dramatic, musical, artistic works or cinematograph films or (b)cinematograph films
Taxability	Service is exempt

Services by a performing artist in folk or classical art forms

S No	Service provider	Service receiver	Service	Taxability
1	Artist of folk music, folk dance and folk theatre	Any person	Performance in folk music, folk dance/Folk theatre	Exempt
2	Artist of Classical music, Classical dance and Classical theatre	Any person	Performance in Classical music, Classical dance/ Classical theatre	Exempt
3	Above (1) and (2) as a brand ambassador	Any person	Performance in above(1) and (2)	Taxable
4	Artist of Western music, mimicry, modern theatre, magic shows	Any person	Performance	Taxable
5	Artists of cinema, television	Any person	Performance	Taxable
6	Artists of Painting, sculpture	Any person	Performance	Taxable

Serving of food or beverages by a restaurant, eating joint or a mess

Coverage:

Service provider	Restaurant, eating joint or a mess,
Service	Serving of food or beverages
Taxability	service is exempt
Exemption not available(Taxable)	(i) Restaurant, eating joint or a mess has the facility of air-conditioning or central air-heating in any part of the establishment, at any time during the year and
	(ii) Restaurant, eating joint or a mess has a licence to serve alcoholic beverages.

Motor vehicle parking to general public

Scope of Exempt Service -

- Services by way of vehicle parking to general public excluding leasing of space to an entity for providing such parking facility.

Coverage 1

Service	Vehicle parking to general public
Taxability	Service is exempt.

Coverage 2

Service	Leasing of land for providing parking facility
Taxability	Service is taxable.

For details more than 100 case studies on Declared services, Negative list of services and Exempted services

Read

- Simplified Approach to IDT, By CCH Publishers, gurgoan
- 3rd edition for May 2013
- Available in all leading book stalls

Online stores: [cchindiastores](http://cchindiastores.com), lawbookshop.net, jainbookdepot.com, flipkart.com

Negative list of Services

Services by Government or a local authority

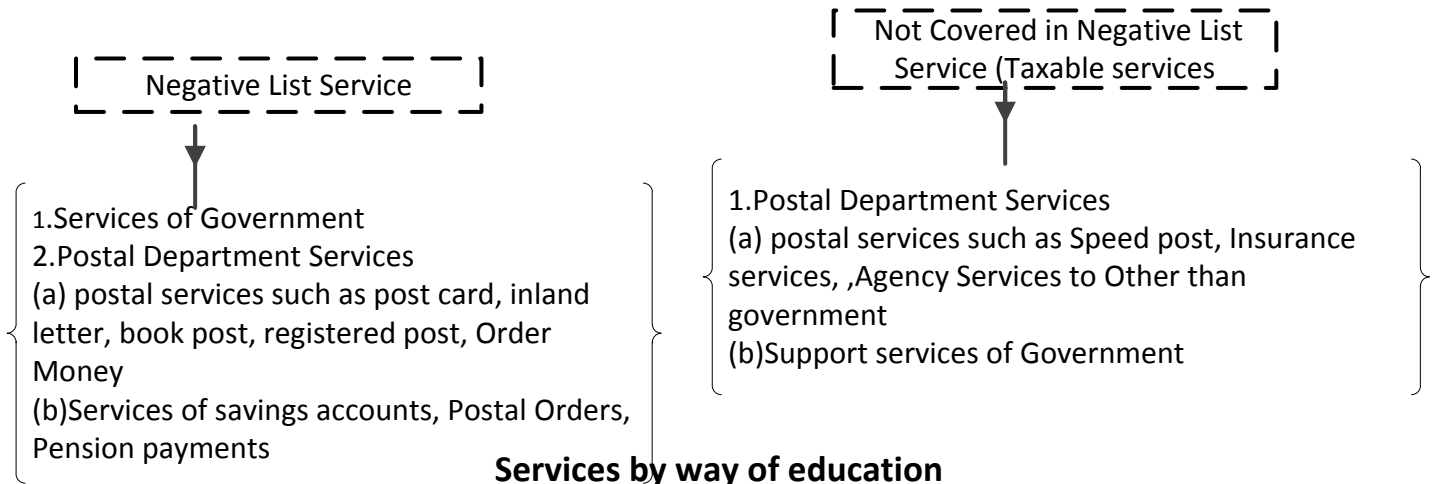

Services by way of education



Coverage under this entry (Not taxable)

- ❖ Service of preschools
- ❖ Service of higher secondary school (may or may not be recognised)
- ❖ Services of Post school education as a part of curriculum for obtaining a qualification recognized by law. Services of colleges/universities of academic, Technical, medical, management where the certificates issued were recognised by Indian law will be covered under this entry. Coaching classes conducted by ICAI, ICWAI and ICSI also covered under this entry.
- ❖ Services of institutes such as “ITI” conducted by approved vocational educational course under apprentice act such as fitter, turner, dress maker, boiler attendant, painter, carpenter etc.,
- ❖ Services of institutes which offer training for Modular Employable Skill Course approved by NCVT such as Automotive repairs, banking, electronic etc.,
- ❖ Services of institutes which offer training in promotion of skill and excellence which is affiliated to NSDC
- ❖ Some other services of educational institutions not covered under this entry, are exempted such as auxiliary educational services etc,. For details refer chapter exempted services.

Services by way of renting of residential dwelling for use as residence

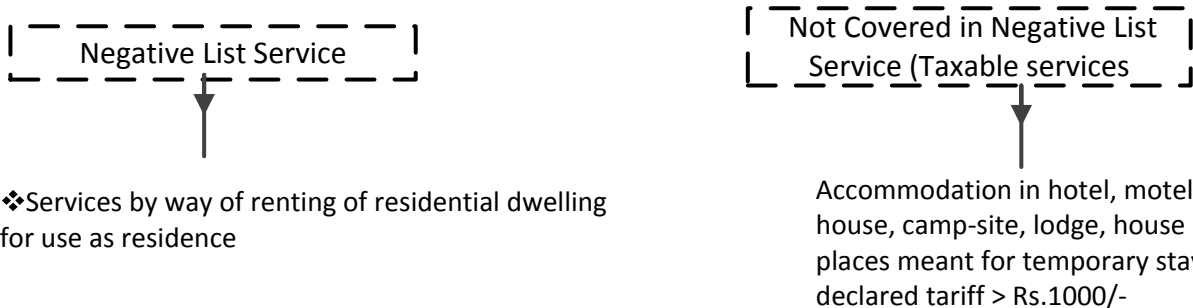

Financial Sector

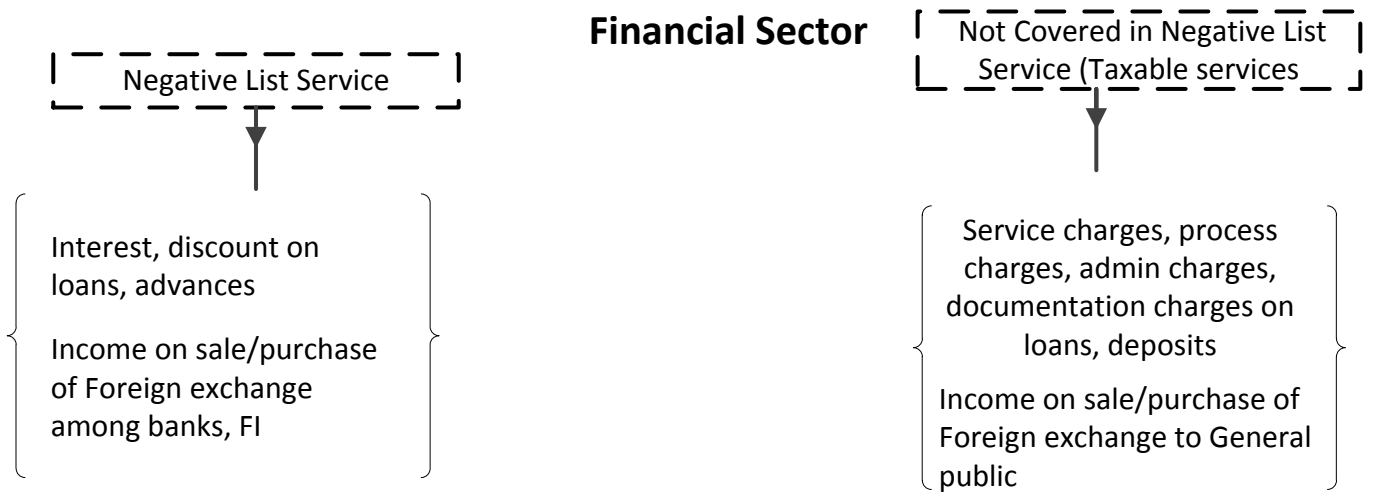

Service of transportation of passengers

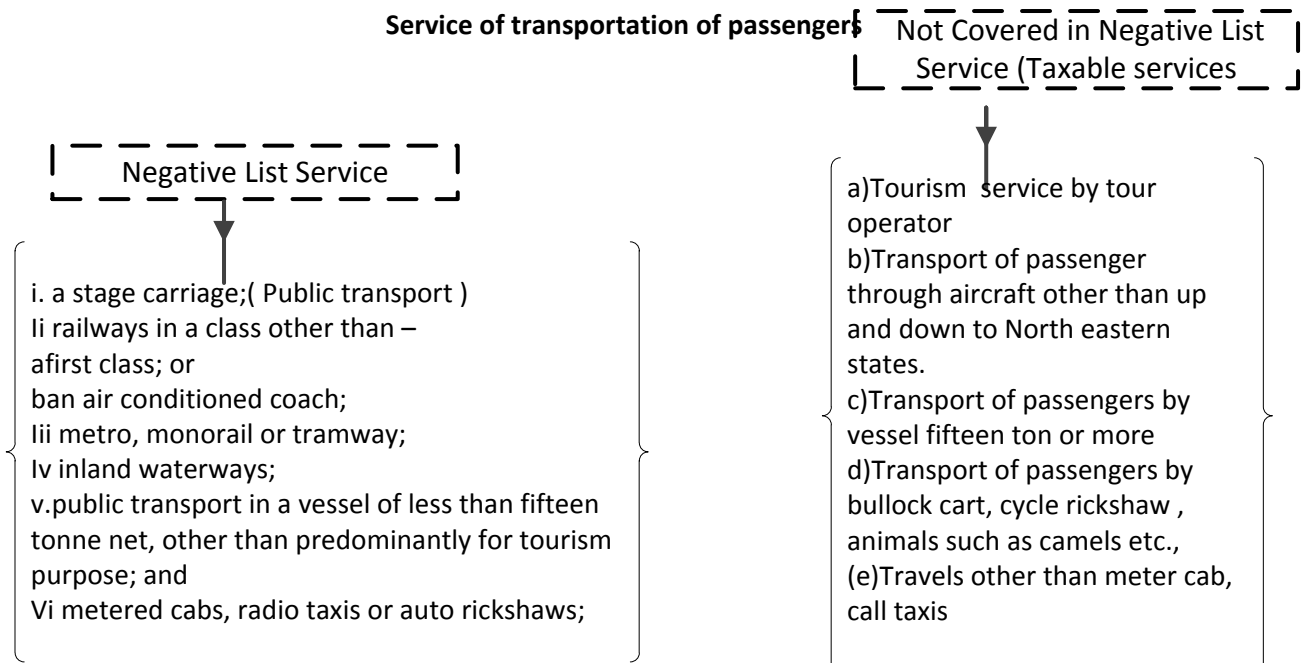

Services by way of transportation of goods

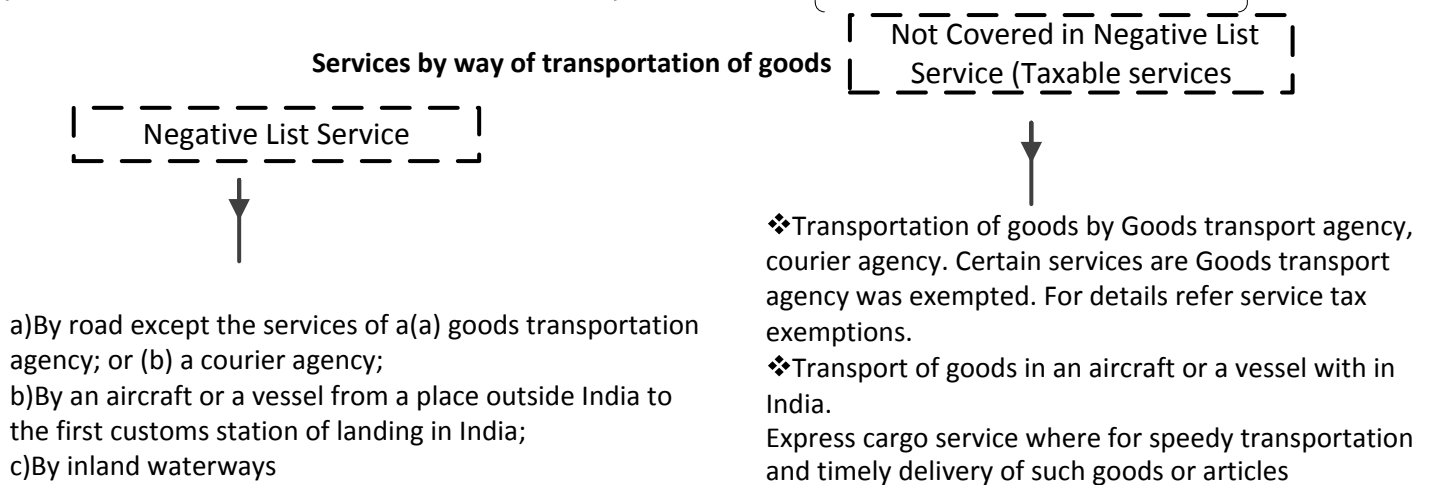

Place of provision rules at glance

Service is taxable only when it is rendered in taxable territory. Whether the service is rendered in taxable territory or not is to be determined as per Place of provision rules as below.

Rule	Applicability	Place of provision of service shall be
3	General rule	location of the recipient of service
4	<p>In case where services are provided in respect of goods that are required to be made physically available to the service provider</p> <p>Example: Repair, reconditioning, or any other work on goods (not amounting to manufacture), storage and warehousing, courier service, dry cleaning</p>	location where the services are actually performed
	<p>In case of services which require the physical presence of the receiver or the person acting on behalf of the receiver, with service provider</p> <p>Example: Cosmetic surgery beautician services, class room teaching, fitness services</p>	
5	<p>In case of services provided directly in relation to an immovable property</p> <p>Ex: Construction, real estate agent, renting, survey, land property management,</p>	Place where the immovable property is located or intended to be located.
6	<p>In case of services provided by way of admission to, or organization of, a cultural, artistic, sporting, scientific, educational, or entertainment event, or a celebration, conference, fair, exhibition, or similar events, and of services ancillary to such admission.</p> <p>Ex: Musical programmers, exhibitions, road show, fashion show</p>	The place where the event is actually held.
7	Where any service referred to in rules 4, 5, or 6 is provided at more than one location, including a location in the taxable territory	location in the taxable territory where the greatest proportion of the service is provided
8	<p>Where the location of the service provider well as that of service receiver is in the taxable territory</p> <p>Ex: Service performed outside India on deputation where both service receiver and service provider is india.</p>	location of the recipient of service

9	In case of (a) Services provided by a banking company, or a financial institution, or a non-banking financial company, to account holders; (b) Online information and database access or retrieval services; (c) Intermediary services; (d) Service consisting of hiring of means of transport, up to a period of one month.	location of the service provider
10	The place of provision of services of transportation of goods, other than by way of mail or courier the place of provision of services of goods transportation agency	place of destination of the goods the location of the person liable to pay tax.
11	In respect of a passenger transportation service	place where the passenger embarks on the conveyance for a continuous journey
12	In case of services provided on board a conveyance during the course of a passenger transport operation, including services intended to be wholly or substantially consumed while on board	the first scheduled point of departure of that conveyance for the journey
13	In order to prevent double taxation or non-taxation of the provision of a service, or for the uniform application of rules, the Central Government shall have the power to notify any description of service or circumstances in which the place of provision shall be the place of effective use and enjoyment of a service.	
14	Notwithstanding anything stated in any rule, where the provision of a service is, prima facie, determinable in terms of more than one rule, it shall be determined in accordance with the rule that occurs later among the rules that merit equal consideration.	

Determination of location of service Provider/Service Receiver. Rule 2(h)(i)

The location of service receiver will be determined as below:

A.	Where the service provider/service receiver has obtained a single registration, whether centralized or otherwise,	The premises for which such registration has been obtained
B	(i) Where the service provider/service receiver is not covered under point A. above	The location of his business establishment
	(ii) <i>Where the services are provided from/used at a place other than the business establishment, that is to say, a fixed establishment elsewhere,</i>	The location of such establishment
	(iii) <i>Where services are provided from/used at more than one establishment, whether business or fixed</i>	The establishment most directly concerned with the provision/use of the service;
	(iv) In the absence of such places (i ,ii & iii)	The usual place of residence

		of the service provider/service receiver.
--	--	-------------------------------------------

Reverse Charge under Service tax

Reverse charge is applicable in the following combinations of Service provider and service receiver. Any other combination of these services ST is payable by Service provider, if the service is not specified in negative list/Service is not exempted.

Services of insurance agent

S.No	Particulars	Particulars
1	Service provider	Insurance Agent
2	Service Receiver	Insurance Company
3	Service tax liability of service provider	NIL
4	Service tax liability of service receiver	100%

2. Services of Goods Transport Agency (GTA)

S.No	Particulars	Particulars
1	Service provider	GTA
2	Service Receiver	Consignor or consignee who is (a) factory, society, registered dealer of excisable goods, body corporate, partnership firm, AOP and (b) who pays or is liable to pay freight either himself or through his agent for transportation of such goods in goods carriage
3	Service tax liability of service provider	NIL
4	Service tax liability of service receiver	100%
5	Explanation	The person who pays or is liable to pay freight for the transportation of goods by road in goods carriage, located in the taxable territory shall be treated as the person who receives the service for the purpose of this notification.. I.e., If such person is located in non-taxable territory, the provider of service shall be liable to pay service tax.

3. Sponsorship service

S.No	Particulars	Particulars
1	Service provider	Any person
2	Service Receiver	Anybody corporate or partnership firm located in the taxable territory
3	Service tax liability of service provider	NIL
4	Service tax liability of service receiver	100%

4. Services of Arbitral tribunal

S.No	Particulars	Particulars
1	Service provider	Arbitral tribunal
2	Service Receiver	Business entity
3	Service tax liability of service provider	NIL
4	Service tax liability of service receiver	100%

5. Services of Legal Services of Advocate or Advocate Firms

S.No	Particulars	Particulars
1	Service provider	Individual Advocate/Advocate firm
2	Service Receiver	Business entity turnover more than Rs.10 lakhs during previous financial year
3	Service tax liability of service provider	NIL

4	Service tax liability of service receiver	100%
---	-------------------------------------------	------

6. Services of director to company (wef. 7-8-2012)

S.No	Particulars	Particulars
1	Service provider	Director
2	Service Receiver	Company
3	Service tax liability of service provider	NIL
4	Service tax liability of service receiver	100%

7.Support Services by Government or Local Authority *excluding* renting of immovable property and services specified in clauses (i), (ii) and (iii) of Section 66D(a) of Finance Act, 1994 (These cover postal, port, airport and railway services)

S.No	Particulars	Particulars
1	Service provider	Government or Local Authority
2	Service Receiver	Business entity located in taxable territory
3	Service tax liability of service provider	NIL
4	Service tax liability of service receiver	100%

8.Service of Renting or hiring of motor vehicle designed to carry passengers to any person who is not in the similar line of business

S.No	Particulars	Particulars
1	Service provider	Individual, HUF, Proprietor, partnership firm, AOP located in taxable territory.
2	Service Receiver	Business entity registered as body corporate located in the taxable territory
3	Service tax liability of service provider	NIL in case of abated value 60% in case of Non abated value
4	Service tax liability of service receiver	100 % in case of abated value 40% in case of Non abated value

9. Services of Supply of Manpower for any purpose or security service (The words '*or security service*' were added w.e.f. 7-8-2012)

S.No	Particulars	Particulars
1	Service provider	Individual, HUF, Proprietor, partnership firm, AOP located in taxable territory.
2	Service Receiver	Business entity of a registered body corporate located in taxable territory
3	Service tax liability of service provider	25%
4	Service tax liability of service receiver	75%

10. Service portion in execution of Works Contract

S.No	Particulars	Particulars
1	Service provider	Individual, HUF, Proprietor, partnership firm, AOP located in taxable territory.
2	Service Receiver	Business entity of a registered body corporate located in taxable territory
3	Service tax liability	50%

	of service provider	
4	Service tax liability of service receiver	50%
5	Explanation	In works contract services, where both service provider and service recipient is the persons liable to pay tax, the service recipient has the option of choosing the valuation method as per choice, independent of valuation method adopted by the provider of service.

11. Services received from non-taxable territory (Import of Service)

S.No	Particulars	Particulars
1	Service provider	Person located in Nontaxable territory
2	Service Receiver	Person located in Taxable territory
3	Service tax liability of service provider	NIL
4	Service tax liability of service receiver	100%

Other important points

- ❖ SR requires registration as a Service receiver liable to pay ST.
- ❖ SR has to pay ST in cash. SR cannot utilize cenvat credit. Once he pays it is input service, he can avail cenvat credit if he is manufacturer/service provider.
- ❖ SP cannot charge ST in invoice in case of reverse charge. SR has to calculate ST on the value and he has to pay. In case of partial reverse charge. SP can charge only his liability portion.
- ❖ The Service tax provisions regarding payment, assessment, refund, recoveries, penalties is also applicable to Service Receiver.

Service tax Valuation

Section 67(1)

Situation	Value
(i) Where total consideration is monetary consideration	Taxable Value = Gross amount charged exclusive of ST
(ii) Where consideration is wholly in kind [non-monetary consideration]	<i>Service Tax (Determination of Value) Rules, 2006, Rule 3(a):</i> Taxable Value = Gross amount charged by service provider for similar service provided to third party If value cannot be determined as above then Taxable Value = Monetary equivalent of “non-monetary consideration”
Where consideration is partly in kind [non-monetary consideration]	<i>Service Tax (Determination of Value) Rules, 2006, Rule 3(b):</i> Taxable Value = [Monetary Consideration + Market Value of Non-monetary Consideration] (but it shall not be less than the cost of provisioning of service)
Where consideration is “not-quantifiable”	Taxable Value = Value determined in prescribed manner No manner has been prescribed so far but it is practically best judgment assessment
Sec 67(2)	ST not collected/not charged –Value to calculate backwards
Sec 67(3)	Gross amount includes part payment/advance payment received/ suspense account
Rule 4	Rejection of Value by CEO : If assessee does not determine value as per sec 67 and SVR he can reject value, issue SCN, give opportunity and determine value
Rule 5	Inclusions of certain expenses/ Reimbursement of expenses not includible in value if act as a pure agent.

Rule 2A - Valuation in case of works contract

- This valuation rule is the subject the provisions of section 67 with regard to valuation.
- The value in case of works contract is:

Gross amount charged excluding Vat on transfer of property on goods	Xxxx
Less: Value of transfer of property in goods involved in execution of contract	Xxxx
Value of works contract service	Xxxx

Exclusions in the gross amount charged

VAT/sales tax paid on transfer of property in goods involved in execution of contract

Inclusions in the gross amount charged

- Labour charges for execution of the works;
- Amount paid to a sub-contractor for labour and services;
- Charges for planning, designing and architect’s fees;
- Charges for obtaining on hire or otherwise, machinery and tools used for the execution of the works contract;
- Cost of consumables such as water, electricity, fuel, used in the execution of the works contract;
- Cost of establishment of the contractor relating to supply of labour and services;
- Other similar expenses relating to supply of labour and services; and
- Profit earned by the service provider relating to supply of labour and services.

Value of transfer of property in goods involved in execution of contract

- ❖ Turnover adopted for local state vat laws can be considered as Value of transfer of property in goods

When the value of goods involved in the works contract is not ascertainable or not available, the value can be determined on the slab rate system as below:

Where works contract is for...	Value of the service portion shall be...
(A) execution of original works	40% of the total amount charged for the works contract
(B) maintenance or repair or reconditioning or restoration or servicing of any goods	70% of the total amount charged for the works contract
(C) in case of other works contracts, not included in serial nos. (A) and (B) above, including contracts for maintenance, repair, completion and finishing services such as glazing, plastering, floor and wall tiling, installation of electrical fittings.	60% of the total amount charged for the works contract

Total amount means

S. No.	Particulars	AMOUNT (in Rs.)
1	Gross amount received excluding taxes	XXXXXXXXXX
2	Fair market value of goods supplied by the service receiver excluding taxes	XXXXXXXXXX
3	Amount charged by service receiver for 2	XXXXXXXXXX
4	Total amount charged (1 +2-3)	XXXXXXXXXX
5	Value of service portion(40% of 4 in case of original works)	XXXXXXXXXX

Rule 2B - Determination of value with regard to money changing

In case	Value of taxable service
(i) Currency is exchanged from, or to, Indian Rupees (INR)	Difference in Buying rate/selling rate and RBI reference rate for that currency at that time* × Total units of currency * Where the RBI reference rate for a currency is not available, the value shall be 1% of the gross amount of Indian Rupees provided or received, by the person changing the money
(ii) Neither of the currencies exchanged is Indian Rupee	1% of the lesser of the two amounts the person changing the money would have received by converting any of the two currencies into Indian Rupee on that day at the reference rate provided by RBI

Rule 2C Determination of value of taxable service involved in supply of food and drinks in a restaurant or as outdoor catering.-

Sl. No.	Description	Value -Percentage of total amount
1.	Service involved in the supply of food or any other article of human consumption or any drink at a restaurant	40
2.	Service involved in the supply of food or any other article of human consumption or any drink as outdoor catering service	60

Total amount means

Particulars	Amount
Total of the gross amount charged	xxxxxxx
Add: the fair market value of all goods and services supplied whether or not under Same contract	xxxxxxx
	xxxxxxx
Less: the amount charged for such goods or services supplied to the service provider, if any	xxxxxxx
Less: the value added tax or sales tax, if any, levied thereon	xxxxxxx
Gross amount charged	xxxxxxx

Point of taxation rules

Note: Individuals, partnership firms this POT rules not applicable when previous FY aggregate taxable services is <= 50 L (details refer ST rule 6)

Rule 3 Point of taxation in normal cases

Rule	Event	Point of taxation
3(a)	If Invoice is issued within 30 days of completion of service	Date/Time of invoice
3(a) proviso	If Invoice not issued within 30 days of completion of service	Date of completion of service
3(b)	If any payment is received (including advance) before the date of completion of service or date of invoice.	Date of receipt of payment. (POT will be up to the extent of payment received)

Examples

Case	Date of completion of service	Date of invoice	Date on which payment received	Point of Taxation	Remarks
1	April 1 st 2012	April 30 th 2012	May 2 nd 2012	April 30 th 2012	Invoice issued within 30 days
2	April 1 st 2012	May 1 st 2012	August 20, 2011 May 2 nd 2012	April 1 st 2012	Invoice not issued within 30 days
3	April 1 st 2012	April 20 th 2012	April 16 th 2012	April 16 th 2012	Payment received after the date of completion of service and before date of invoice.
4	April 20 th 2012	April 30 th 2012	Part payment received on April 10 th 2012	April 10 th 2012 to the extent of Part payment.	Payment received before the date of Completion of service

Determination of point of taxation in case of continuous supply of service

❖ Same as above except, invoice is to be raised from the date of completion of an event

Meaning of Date of payment

1	Normal cases	Date of entry in books or date of crediting in bank account, Whichever earlier.
2	Special cases in case of Change in effective rate of tax	
(a)	Rate changes between entry in books and credited in bank account	Payment is credited within 4 days from the effective date of new rate- date of entry in the books is the date of payment Otherwise, date of Crediting in the bank account is the date of payment
(b)	New service brought in to service	Same as above

	tax between entry in books and credited in bank account	
--	---------------------------------------------------------	--

Rule 4 - Determination of point of taxation in case of change in effective rate of tax (CERT)

1	Date of provision of service	Any two Before change in rate- Old rate
2	Date of issue of invoice	
3	Date of receipt of payment	Any two after change in rate- New rate

Rule 5 – Point of tax in cases of new services (New service brought under tax net)

Rule	Event	Point of taxation
5(a)	Invoice issued <i>and</i> payment received before service became taxable	No service tax
(b)	Payment received before service became taxable and invoice issued after service became taxable within 14 days	No service tax

Rule 7 - Determination of point of taxation in case of specified services or persons

Rule	Event	Point of taxation
7	Receipt of service & Payment made in advance or within 6 months from the date of invoice of service provider	Date of payment
proviso	Receipt of service, Payment not made within 6 months from the date of invoice of service provider	As per Rule 3, 4, 5, or 8, as the case may be

Service received from associated enterprise when service provider is located outside India

Rule 7	Event	Point of taxation
Second proviso	Providing of service	Date of credit in books of account of person receiving service or Date of making payment whichever is earlier

Rule 8 - Intellectual Property Service (copyright, trade mark, design or patent), where consideration not ascertainable at the time of service

Rule 8	Event	Point of taxation
8	Providing of service	Receipt of payment by service provider or Invoice issued by service provider whichever is earlier

Note: If the consideration is ascertainable at the time of service Rule 3 is applicable

Rule 8A Determination of point of taxation in other cases

Where the point of taxation cannot be determined as per these rules as the date of invoice or the date of payment or both are not available, the Central Excise officer, may, require the concerned person to produce such accounts, documents or other evidence as he may deem necessary and after taking into

account such material and the effective rate of tax prevalent at different points of time, shall, by an order in writing, after giving an opportunity of being heard, determine the point of taxation to the best of his judgment]

Rule 9 - Transitional Provisions

Rule	Event	Point of taxation
9	Invoice issued/service completed before 01.04.2011	POT rules are not applicable Service Tax on receipt basis
Proviso	Invoice issued/service completed before 30.06.2011	At the option of assessee either under POT rules or Service Tax on receipt basis

Service tax Registration

Service tax procedures -1

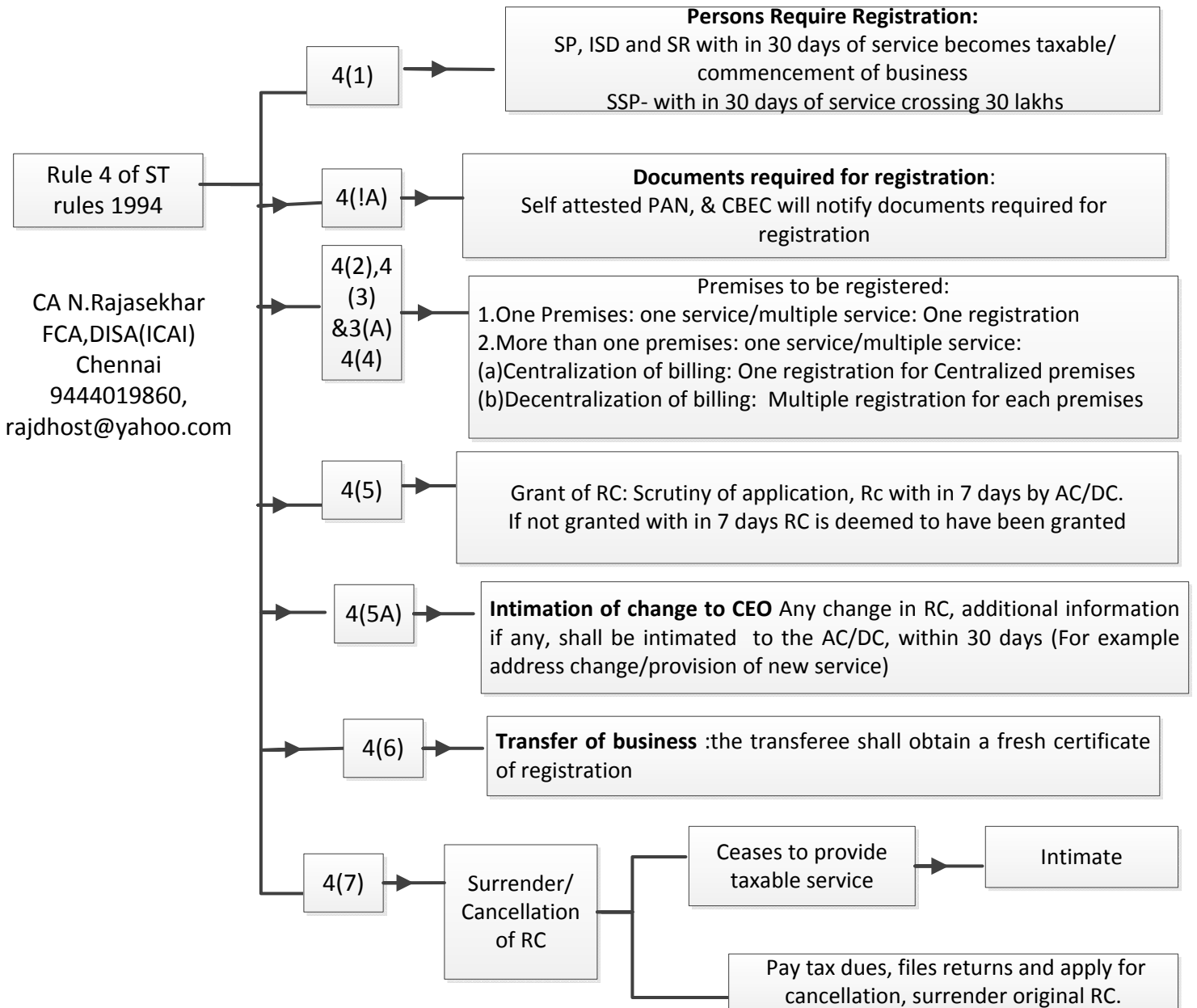

Service tax procedures -2

ST- Payment

Rule 6(1)

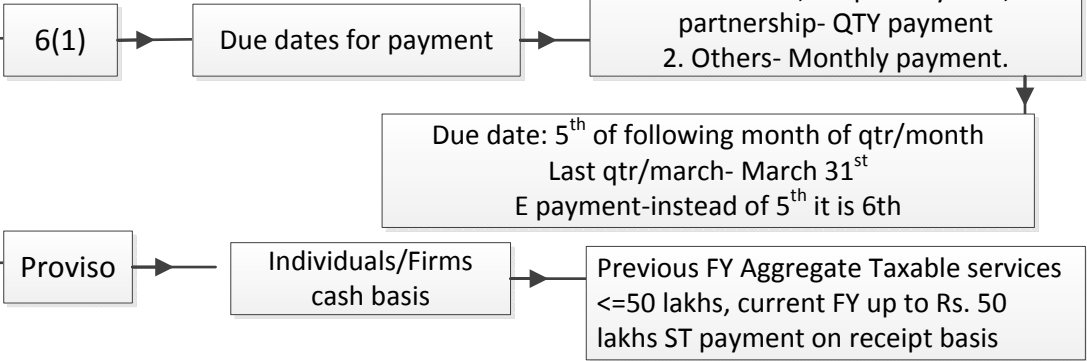

CA N.Rajasekhar
FCA,DISA(ICAI)
Chennai
9444019860,
rajdhost@yahoo.com

Rule 6(1A) to Rule 7(c)

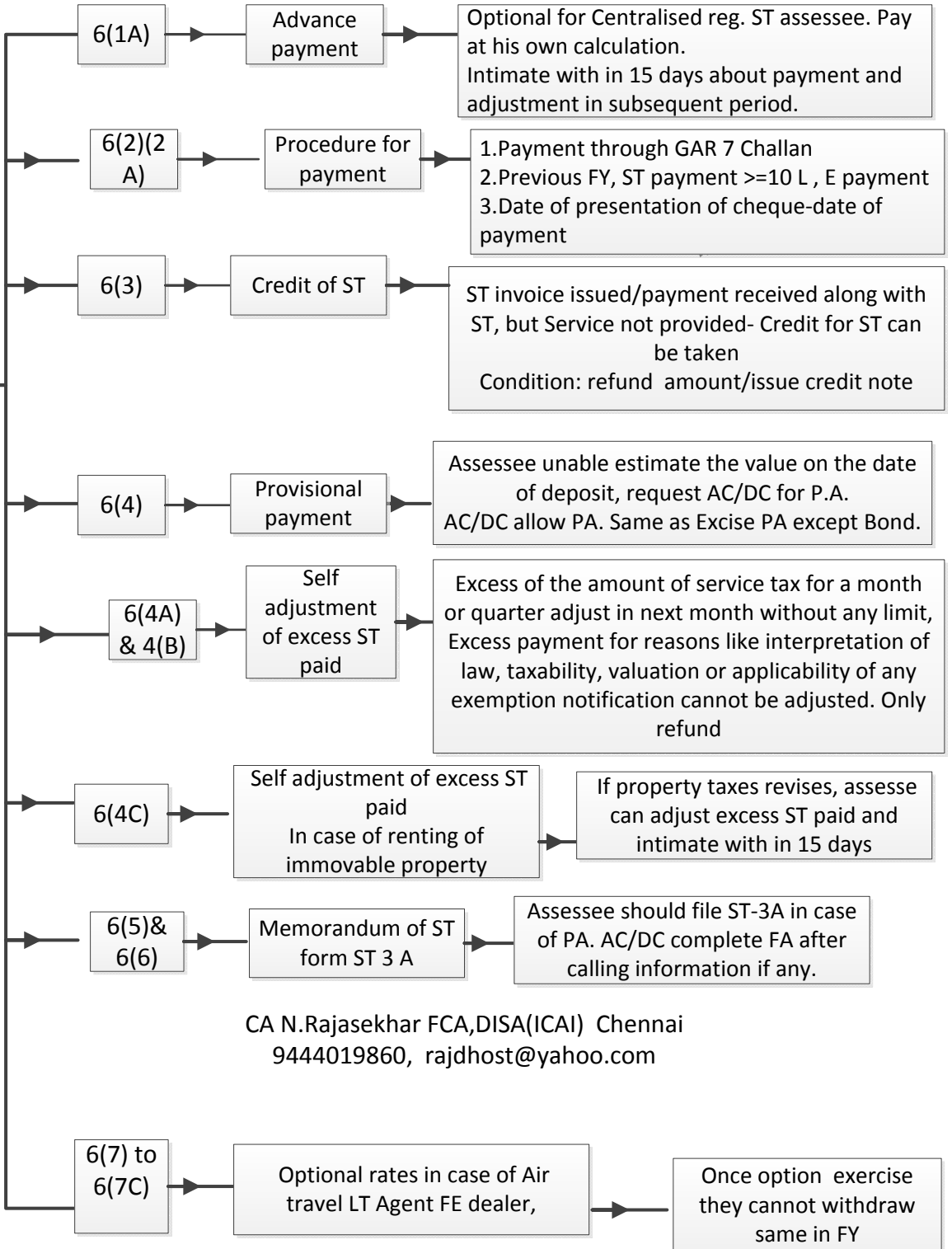

CA N.Rajasekhar FCA,DISA(ICAI) Chennai
9444019860, rajdhost@yahoo.com

Service tax procedures -3

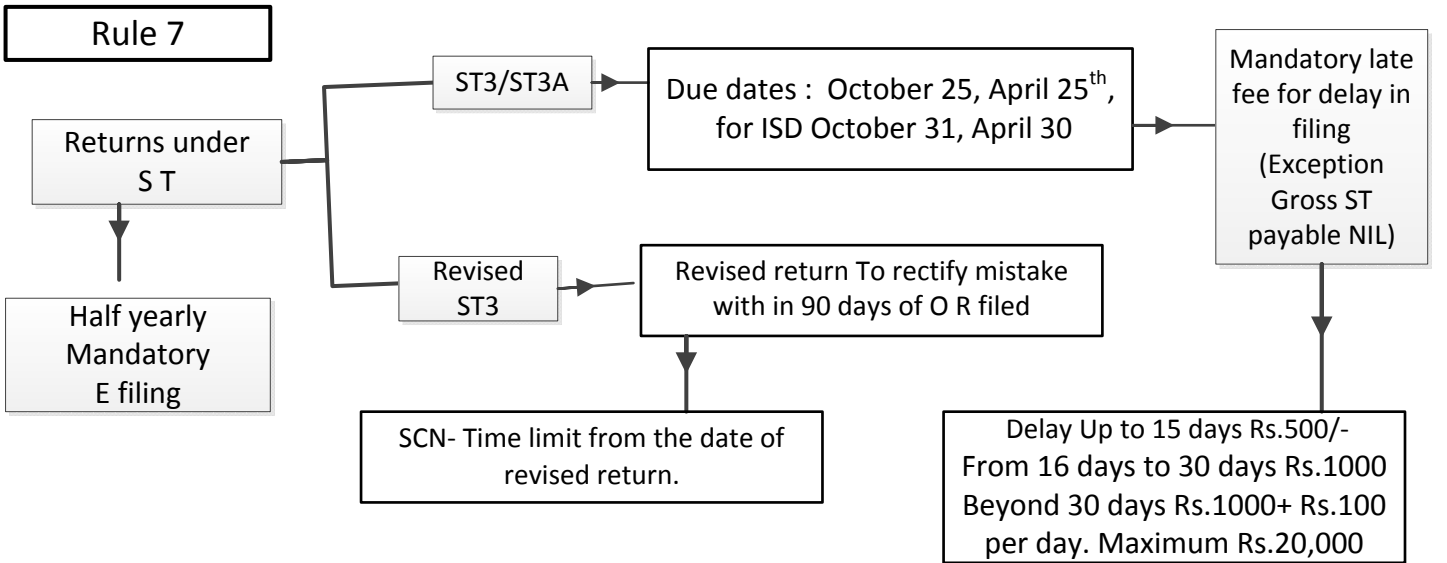
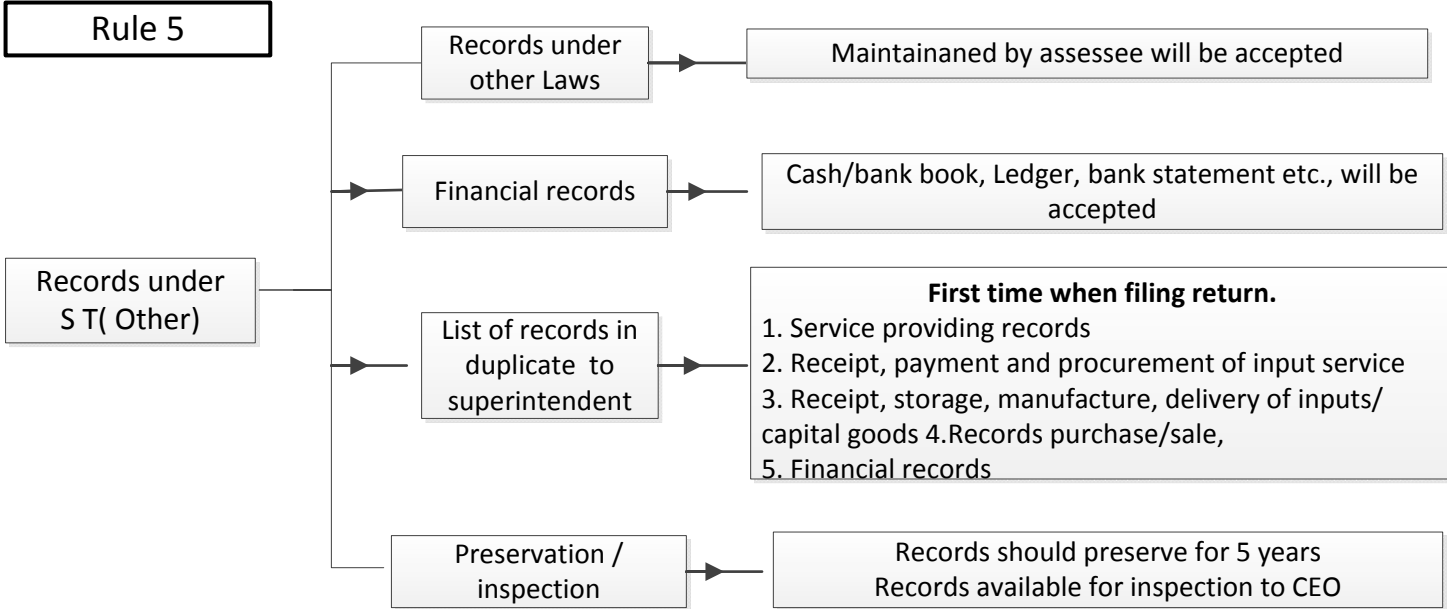
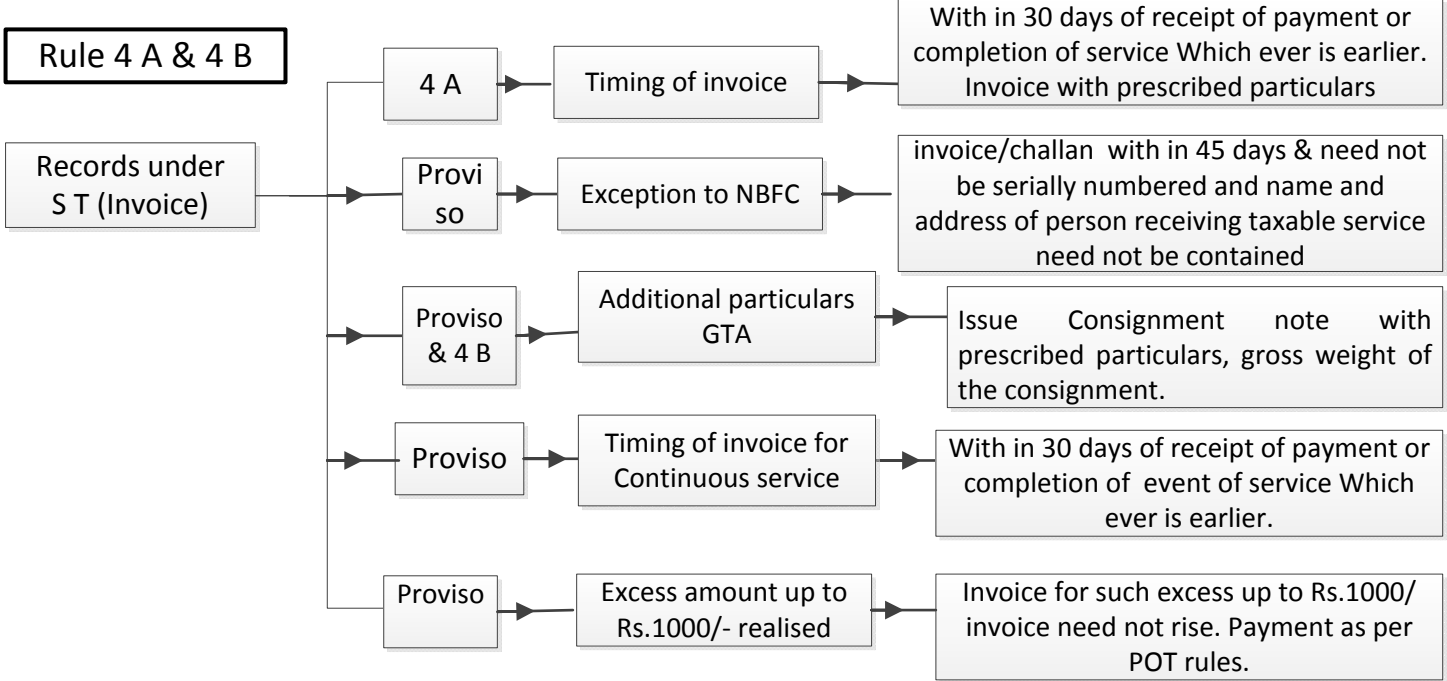

Penalties under Service tax

S. No.	Section	Nature of Violation	Penalty
1.	76	Failure to pay Service tax	Not less than Rs.100 per day of default or 1% per month of tax whichever is higher. In no case penalty can exceed the 50% of tax.
2.	77(1)(a)	Failure to get registration	Rs.10,000 or Rs.200 per day from the first day after due date, whichever is higher.date till the day of actual compliance.
3.	77(1)(b)	Failure to maintain books of accounts.	Maximum Rs.10,000
4.	77 (1)(c)	Failure to furnish information called by Central Excise Officer	Rs.5,000 or Rs.200 per day whichever is higher from the first day after due date till the day of actual compliance.
5.	77(1)(c)	Failure to appear before the Central Excise Officer when issued with a summon for appearance to give evidence or to produce document.	Rs.5,000 or Rs.200 per day whichever is higher from the first day after due date till the day of actual compliance.
6.	77 (1)(d)	Fails to pay tax through e-payment	Maximum Rs.10,000
7.	77(1)(e)	Issue invoice with incorrect details, fails to account invoice in books	Maximum Rs.10,000
8.	77(2)	Contravention of law Where no penalty is mentioned	Maximum Rs.10,000
9.	78(1)	Suppression of Value (fraud cases)	Equal to the amount of tax. Penalty is reduced to 25% of service tax if tax and interest are paid within 30 days.

Section 80 - Waiver of Penalty

No penalty will be levied under sections 76, 77 and 78(1), if the assessee proves that there is a reasonable and sufficient cause for failure to comply.

Prosecution provisions (Criminal Penalties) - Section 89

1	Providing/receiving taxable service without issue invoice
2	Avails and utilises credit of taxes or duty without actual receipt of taxable service or excisable goods either fully or partially
3	Maintains false books of account or fails to supply any information/supply false information

Term of imprisonment

If any person is convicted of an offence under this section for the:		
First time	In the case of an offence where the amount is	Term of imprisonment
	(i) up to `50 lakh	Up to 1 year
	(ii) more than `50 lakh	6 months to 3 years
Second and every subsequent time	Irrespective of the amount of tax, The term of imprisonment shall be 6 months to 3 years	
Such imprisonment shall be for a term of less than six months if there are special and adequate reasons to be recorded in the judgment of the Court.(this provision same as central excise)		

A person shall not be prosecuted for any offence under this section except with the previous sanction of the Chief Commissioner of Central Excise.